The background features soft, out-of-focus shadows of plants. In the upper right, there are two curved, vine-like shadows with small, heart-shaped leaves. In the lower left, there is a larger, more detailed shadow of a fern frond.

zafferano
LAMPES-À-PORTER

zafferano
LAMPES-À-PORTER

E se fosse una lampada a illuminare l'inaspettato?

What if a lamp
could light up the unexpected?



Questo che vi proponiamo
è un breve viaggio nella natura
natura protagonista con la sua intatta bellezza.
Lampade che fanno da contrappunto a questi paesaggi
accoglienti e disponibili
offrono luoghi inaspettati, inconsueti
dove la luce, compagna fedele,
fa riscoprire colori e profili
che i tramonti vanno via via dileguando
inghiottiti dall'oscurità.

What we propose
is a short journey into nature.
With its unspoilt beauty, nature is the protagonist.
Lamps bring a contrast to these
welcoming and receptive landscapes.
They offer unexpected and unusual places,
where light, a faithful companion,
lets you rediscover colours and profiles
that sunsets gradually fade away
swallowed by darkness.

Indice delle collezioni

Collections overview

06	12	22	26	32	36	40	44
Poldina	Tavolo Table lamp	Mini tavolo Mini table lamp	Micro tavolo Micro table lamp	L desk tavolo L desk table lamp	L terra-tavolo L floor-table lamp	XXL terra-tavolo XXL floor-table lamp	Picchetto Lamp with peg
48	52	56	60	62	72	76	78
Sospensione Suspension lamp	Parete Wall lamp	Cover Cover	Poldina Reverso	Tavolo Table lamp	Poldina Stopper	Stopper	Bottiglia Bottle
82	86	90	94	98	102	106	
Ofelia	Tavolo Table lamp	Micro tavolo Micro table lamp	Olivia	Tavolo Table lamp	Mini tavolo Mini table lamp	Micro tavolo Micro table lamp	
110	116	120	124	128	130	140	134
Pina	Tavolo Table lamp	Supporto terra Floor stand	Vassoio Tray	Swap	Tavolo Table lamp	Mini tavolo Mini table lamp	Paralumi Lampshades
148	150	154	156	160	162	166	168
Push-up	Tavolo Table lamp	Home	Tavolo Table lamp	Supporto parete Wall lamp kit	Solar terra Solar floor lamp	Dama	Tavolo Table lamp

172	174	178	188	190	192	194	
Olimpia	Tavolo Table lamp	Sister Light Wi-Fi	Tavolo Table lamp	Mini tavolo Mini table lamp	Picchetto Lamp with peg	Parete Wall lamp	
196	200	206	210	212	214	216	218
Pencil	Modulo luminoso con accessori Lighting module with accessories						
220	226	228	230	232	234	236	242
Amelie	Tavolo Table lamp	Terra Floor lamp	Picchetto Lamp with peg	Sospensione Suspension lamp	Parete Wall lamp	Circe	Tavolo Table lamp
244	246	248	250	252	254		
Super O	Tavolo Table lamp	Terra Floor lamp	Terra sospesa Ceiling-suspended floor lamp	Sospensione Suspension lamp	Parete Wall lamp		
258	262	264					270
Liola	Tavolino Table	Accessori Accessories	Basi di ricarica Charging bases				Batterie Battery packs

Poldina

Sembri nata dalle terre umide
mentre la vicina laguna
risplende del finire del sole.
Piccola, illumini
in un contrasto concreto e voluto
gli arbusti selvaggi e profumati.

You appear to have come from the wetlands
while the nearby lagoon
glows in the setting sun.
Little one, you illuminate
with a distinct, intentional contrast
wild and fragrant shrubs.

TAVOLO / MINI TAVOLO / MICRO TAVOLO / L DESK TAVOLO / L TERRA-TAVOLO / XXL TERRA-TAVOLO / PICCHETTO / SOSPENSIONE /
PARETE / ACCESSORI
TABLE LAMP / MINI TABLE LAMP / MICRO TABLE LAMP / L DESK TABLE LAMP / L FLOOR-TABLE LAMP / XXL FLOOR-TABLE LAMP /
LAMP WITH PEG / SUSPENSION LAMP / WALL LAMP / ACCESSORIES



Poldina lamp with peg white
→ **LD0682B3**
Porto Caleri
Rovigo, Italy



Previous page:
Poldina table lamp white → **LD0340B3**
Poldina table lamp dark grey → **LD0340N3**

Current page: Poldina XXL floor-table
lamp dark grey → **LD0360N3**
Linder Cycling Hotel - Bolzano, Italy
Photo Tiberio Sorvillo

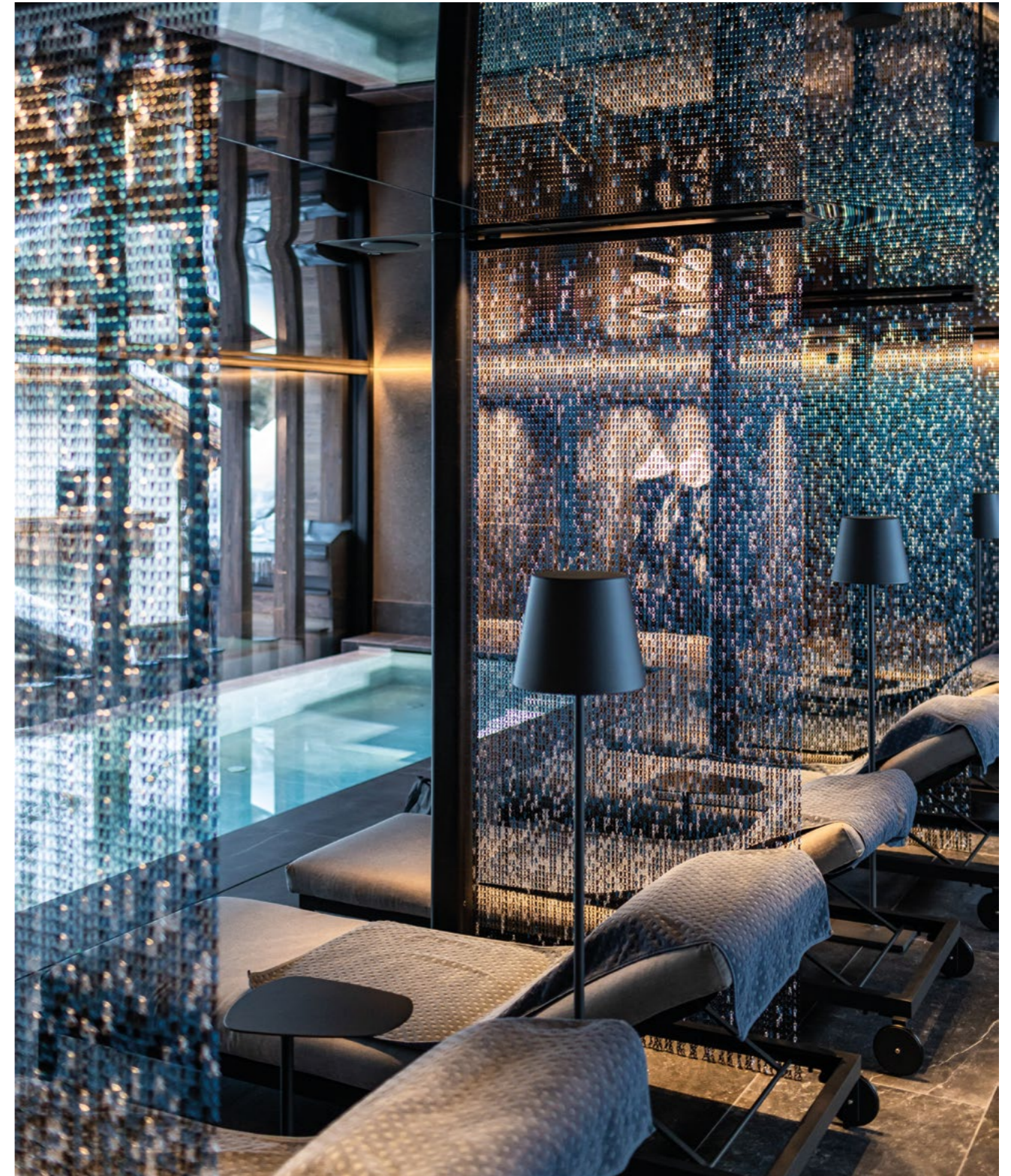



Current page: Poldina table
lamp corten → **LD0340R3**

Natu Restaurant, Athens
Greece

Arch. Photography Giorgos Sfakianakis

Next page: Poldina mini
table lamp white → **LD0320B3**

Gran Caffè Quadri, Piazza San Marco
Venice, Italy

Photo Maurizio Torresan Photographer

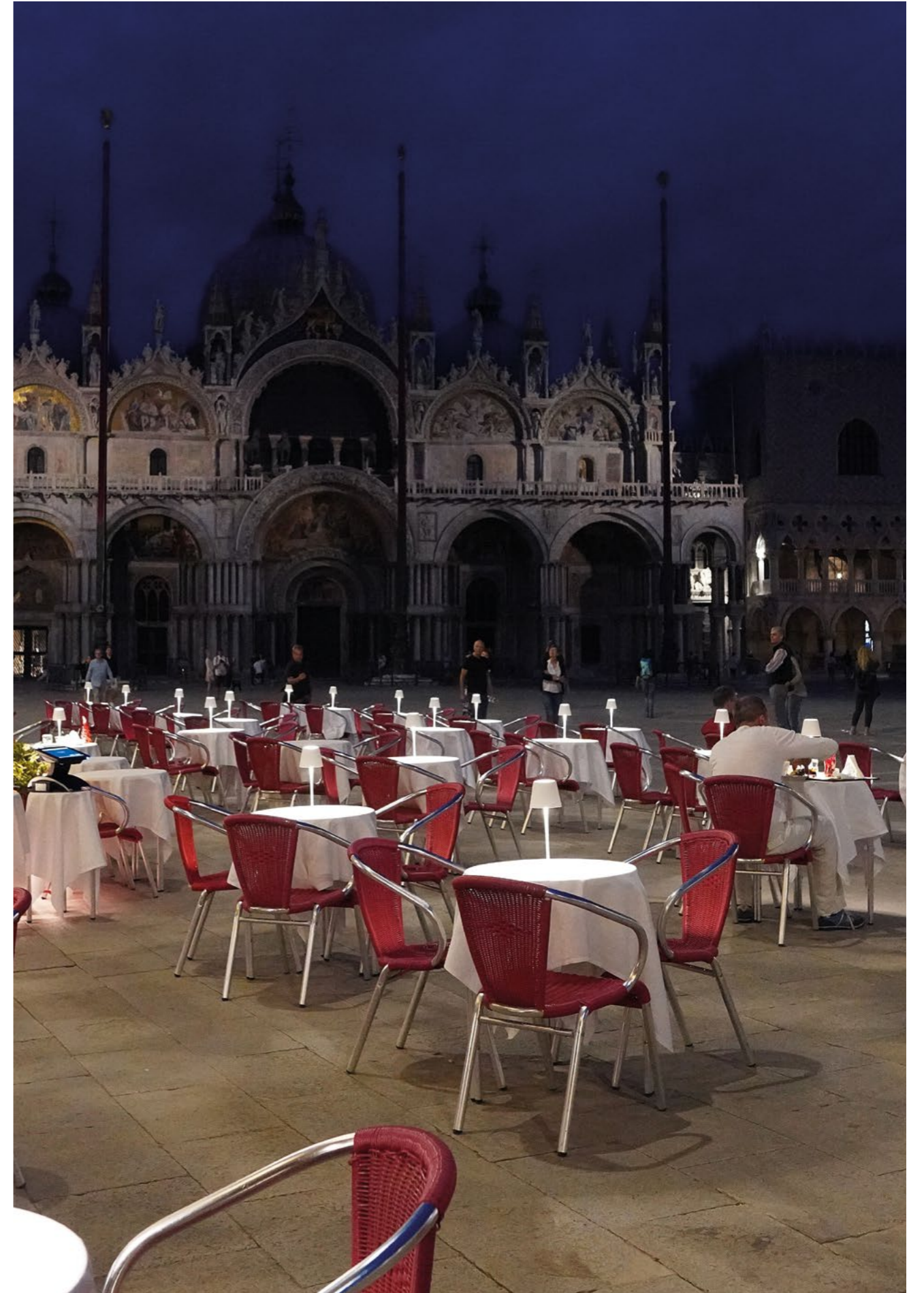

Poldina

Tavolo pro Table lamp pro



Video Poldina



Poldina è una lampada da tavolo a batteria, portatile e ricaricabile. Nella parte superiore della testa è presente un controllo "touch", che permette l'accensione, la regolazione dell'intensità luminosa e la selezione della temperatura di colore della luce tra 2200K, 2700K e 3000K. Grazie a un alto indice di protezione, la lampada è utilizzabile anche all'esterno (ad eccezione dei modelli con finitura a foglia metallica e finitura galvanica, delle quali è sconsigliato l'uso continuativo in esterni). Possiede un sistema di controllo elettronico che monitora e segnala l'autonomia residua della batteria, permettendo di ottimizzare le ricariche ed effettuarle sempre in maniera corretta. È dotata di base di ricarica a contatto; caricabatterie incluso. È possibile personalizzare la lampada con cover in ceramica, acquistabili separatamente.

Poldina is a rechargeable battery-powered cordless table lamp. A "touch" control on the head allows switching on/off, dimming, and selecting the color temperature of the light (2200K, 2700K or 3000K). It is suitable for both indoor and outdoor use (except gold, silver, and copper finishes). An electronic control system monitors the remaining autonomy and ensures a constant luminous flux until the battery runs out. Recharging is therefore optimized and always properly done. Poldina comes with a contact charging base; the battery charger is included. The lamp can be customized with a ceramic cover, to be purchased separately.

Dati tecnici Technical data

LED TOUCH DIMMER | 100-240V | 2200-2700-3000K | CRI>80 | 50-60Hz | 2,2W | 234-251-256lm | **IP65** | 5Vdc max 1A

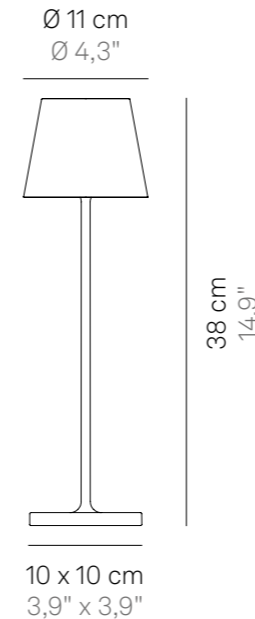

9,4 x 9,4 cm
3,7" x 3,7"

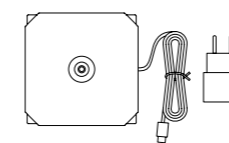

Componenti inclusi Components included

Base di ricarica a contatto
Contact charging base
Caricabatterie
Charger

Corpo in pressofusione di alluminio verniciato
Painted die-cast aluminum body

Schermo diffusore in policarbonato
Polycarbonate diffuser

Adatta all'uso esterno (lampada IP65) e interno (lampada su base di ricarica IP20)

Suitable for outdoor (lamp IP65) and indoor use (lamp on charging base IP20)

Durata di circa 12 h alla massima potenza
Battery lasts about 12 h at full power

Tempo di ricarica a 1A: 6/7 h
Charging time at 1A: 6/7 h

Pacco batteria al litio ricaricabile e sostituibile
Rechargeable and replaceable lithium battery pack

Avvertenze Remarks

Le lampade con finitura foglia color oro, foglia color argento e foglia color rame e con finitura galvanica lucida oro e cromo non sono adatte per uso esterno. The lamps with gold color leaf, silver color leaf and copper color leaf finish and with gold and chrome glossy galvanic finish are not suitable for outdoor use.

Per effetto della natura manuale della tecnica adottata nella lavorazione con foglia metallica, l'aspetto finale della finitura delle lampade può risultare differente. Eventuali difformità attestano il pregio e l'unicità di ciascuna lampada e non vanno considerate come imperfezioni. Due to the manual nature of the technique adopted in the application of the metal foil, the final appearance of the lamps' finishing can be different. Any apparent imperfections attest to the quality and exclusivity of each lamp and should not be considered as imperfections.

Finiture
Finishes



LD0340B3
Bianco / White
RAL 9003



LD0340R3
Corten



LD0340N3
Grigio scuro / Dark gray



LD0340S3
Sabbia / Sand

Finiture
Finishes



LD0340G3
Salvia / Sage green
Pantone 5635 U



LD0340A3
Blu avio / Avio blue
Pantone 7468 U



LD0340P3
Rosa / Pink
Pantone 698 U



LD0340F3
Rosso / Red
RAL 3000



LD0340X3
Bordeaux / Burgundy
RAL 3005



LD0340M3
Verde scuro / Dark green
RAL 6005



LD0340D3
Nero / Black
RAL 9004



LD0340O3
Oro lucido
/ Glossy gold



LD0340C3
Cromo lucido
/ Glossy chrome

Finiture
Finishes



LD0340BFO
Foglia color oro
/ Gold color leaf
RAL 9003



LD0340BFA
Foglia color argento
/ Silver color leaf
RAL 9003



LD0340FRF
Foglia color rame
/ Copper color leaf



LD0340DFO
Nero - Foglia color oro
craquelé
/ Black - Gold color leaf
RAL 9004



LD0340AFO
Blu avio - Foglia color
oro craquelé / Avio blue -
Gold color leaf craquelé
Pantone 7468 U



LD0340FFO
Rosso - Foglia color oro
craquelé / Red - Gold
color leaf craquelé
RAL 3000



Nuova finitura craquelé
New craquelé finish

* Le lampade con finitura foglia color oro, foglia color argento, foglia color rame e con finitura craquelé non sono adatte per uso esterno.
* The lamps with gold color leaf, silver color leaf, copper color leaf finish and the lamps with craquelé finish are not suitable for outdoor use.

poldina x PEANUTS

Tavolo pro
Table lamp pro



Poldina x Peanuts è l'edizione speciale di Poldina, lampada da tavolo a batteria portatile e ricaricabile, personalizzata con i personaggi creati da Charles Schulz. Peanuts, la striscia creata da Charles Schulz e pubblicata dal 1950, è uno dei fumetti più conosciuti al mondo. Poetici, teneri e ironici, i suoi personaggi sono figure classiche e senza tempo, in cui ogni lettore può riconoscersi.

Poldina x Peanuts is a special edition of the rechargeable battery-powered cordless table lamp Poldina, customized with characters created by Charles Schulz. Peanuts, first published in 1950, is one of the best-known comic strips in the world. Each member of the Peanuts gang is a classic, timeless figure with whom every reader can identify.

Poldina x Peanuts table lamp
Aviator → **LD0340FP1**



Dati tecnici

Technical data

LED TOUCH DIMMER | 100-240V | 2200-2700-3000K | CRI>80 | 50-60Hz | 2,2W | 234-251-256lm | **IP65** | 5Vdc max 1A



Corpo in pressofusione di alluminio verniciato

Painted die-cast aluminum body

Schermo diffusore in policarbonato

Polycarbonate diffuser

Adatta all'uso esterno (lampada IP65) e interno (lampada su base di ricarica IP20)

Suitable for outdoor (lamp IP65) and indoor use (lamp on charging base IP20)

Durata di circa 12 h alla massima potenza

Battery lasts about 12 h at full power

Tempo di ricarica a 1A: 6/7 h

Charging time at 1A: 6/7 h

Pacco batteria al litio ricaricabile e sostituibile

Rechargeable and replaceable lithium battery pack

Ø 11 cm
Ø 4,3"

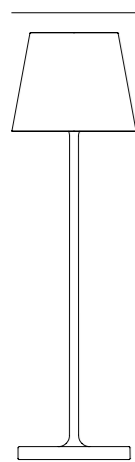

38 cm
14,9"

10 x 10 cm
3,9" x 3,9"

9,4 x 9,4 cm
3,7" x 3,7"

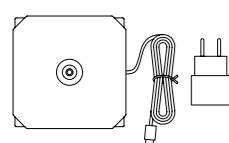
**Componenti inclusi**

Components included

Base di ricarica a contatto

Contact charging base

Caricabatterie

Charger

Finiture

Finishes

**LD0340FP1**

Aviator

RAL 3000

**LD0340BP2**

Heart

RAL 9003

**LD0340BP3**

Friends

RAL 9003

**LD0340BP4**

Strip

RAL 9003

**LD0340RP5**

Together



Poldina mini

Tavolo pro Table lamp pro



Poldina mini è una lampada da tavolo a batteria, portatile e ricaricabile. Nella parte superiore della testa è presente un controllo "touch", che permette l'accensione, la regolazione dell'intensità luminosa e la selezione della temperatura di colore della luce tra 2200K, 2700K e 3000K. Grazie a un alto indice di protezione, la lampada è utilizzabile anche all'esterno (ad eccezione dei modelli con finitura a foglia metallica e finitura galvanica, delle quali è sconsigliato l'uso continuativo in esterni). Possiede un sistema di controllo elettronico che monitora e segnala l'autonomia residua della batteria, permettendo di ottimizzare le ricariche ed effettuarle sempre in maniera corretta. È dotata di base di ricarica a contatto; caricabatterie incluso. È possibile personalizzare la lampada con cover in ceramica, acquistabili separatamente

Poldina mini is a rechargeable battery-powered cordless table lamp. A "touch" control on the head allows switching on/off, dimming, and selecting the color temperature of the light (2200K, 2700K or 3000K). It is suitable for both indoor and outdoor use (except gold, silver, and copper finishes). An electronic control system monitors the remaining autonomy and ensures a constant luminous flux until the battery runs out. Recharging is therefore optimized and always properly done. Poldina comes with a contact charging base; the battery charger is included. The lamp can be customized with a ceramic cover, to be purchased separately

Dati tecnici Technical data

LED TOUCH DIMMER | 100-240V | 2200-2700-3000K | CRI>80 | 50-60Hz | 2,2W | 234-251-256lm | **IP65** | 5Vdc max 1A

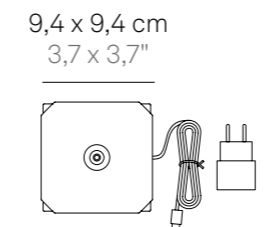
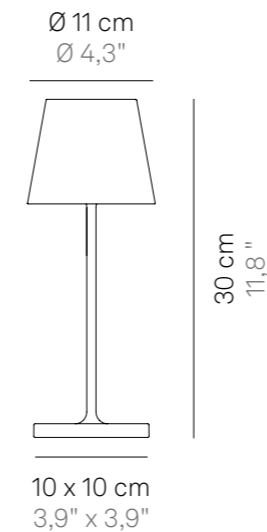

Corpo in pressofusione di alluminio verniciato
Painted die-cast aluminum body

Schermo diffusore in policarbonato
Polycarbonate diffuser

Adatta all'uso esterno (lampada IP65) e interno (lampada su base di ricarica IP20)

Suitable for outdoor (lamp IP65) and indoor use (lamp on charging base IP20)

Durata di circa 12 h alla massima potenza
Battery lasts about 12 h at full power

Tempo di ricarica a 1A: 6/7 h
Charging time at 1A: 6/7 h

Pacco batteria al litio ricaricabile e sostituibile
Rechargeable and replaceable lithium battery pack

Avvertenze Remarks

Le lampade con finitura foglia color oro, foglia color argento e foglia color rame e con finitura galvanica lucida oro e cromo non sono adatte per uso esterno. The lamps with gold color leaf, silver color leaf and copper color leaf finish and with gold and chrome glossy galvanic finish are not suitable for outdoor use.

Per effetto della natura manuale della tecnica adottata nella lavorazione con foglia metallica, l'aspetto finale della finitura delle lampade può risultare differente. Eventuali difformità attestano il pregio e l'unicità di ciascuna lampada e non vanno considerate come imperfezioni.

Due to the manual nature of the technique adopted in the application of the metal foil, the final appearance of the lamps' finishing can be different. Any apparent imperfections attest to the quality and exclusivity of each lamp and should not be considered as imperfections.

Componenti inclusi Components included

Base di ricarica a contatto
Contact charging base

Caricabatterie
Charger

Finiture
Finishes



LD0320B3

Bianco / White
RAL 9003

LD0320R3

Corten

LD0320N3

Grigio scuro / Dark grey

LD0320S3

Sabbia / Sand

Finiture
Finishes



LD0320BFO *

Foglia color oro
/ Gold color leaf

LD0320BFA *

Foglia color argento
/ Silver color leaf

LD0320RFR *

Foglia color rame
/ Copper color leaf

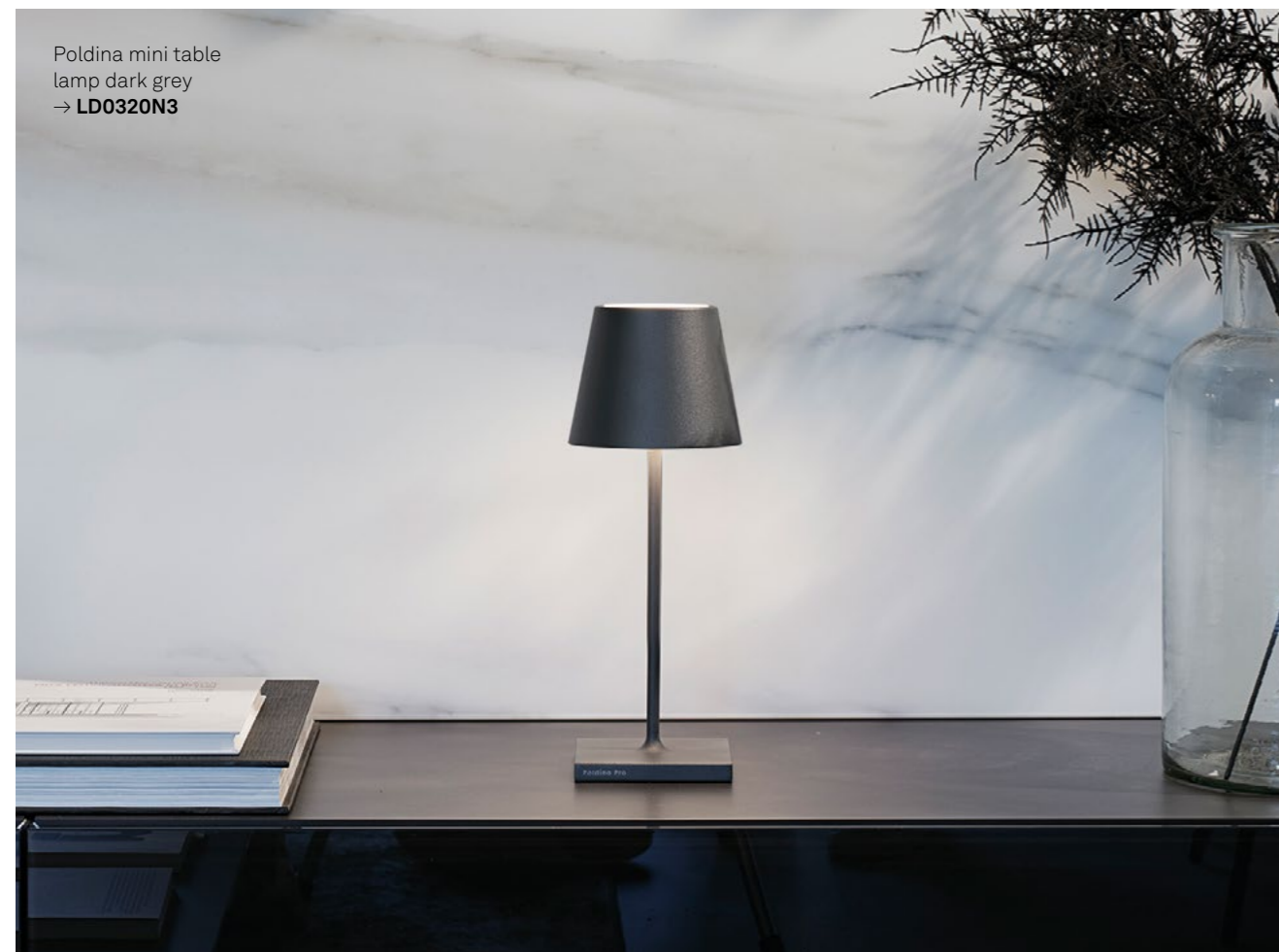

Poldina mini table
lamp dark grey
→ **LD0320N3**



LD0320O3 *

Oro lucido
/ Glossy gold

LD0320C3 *

Cromo lucido
/ Glossy chrome

* Le lampade con finitura foglia color oro, foglia color argento e foglia color rame e con finitura galvanica lucida oro e cromo non sono adatte per uso esterno. Le finiture cromate sono dotate della funzione di selezione della temperatura di colore della luce tra 2700 K e 3000 K.

* The lamps with gold color leaf, silver color leaf, copper color leaf finish and with gold and chrome glossy galvanic finish are not suitable for outdoor use. The lamps with glossy finish are equipped with a light color temperature selection function 2700 K or 3000 K.

Poldina micro

Tavolo pro Table lamp pro



Premio Barawards 2022
Innovazione dell'Anno

Barawards 2022 Innovation
of the Year Award



Poldina micro è una lampada da tavolo a batteria, portatile e ricaricabile. Nella parte superiore della testa è presente un controllo "touch", che permette l'accensione, la regolazione dell'intensità luminosa e la selezione della temperatura di colore della luce tra 2200K, 2700K e 3000K. Grazie a un alto indice di protezione, la lampada è utilizzabile anche all'esterno (ad eccezione dei modelli con finitura galvanica, delle quali è sconsigliato l'uso continuativo in esterni). Possiede un sistema di controllo elettronico che monitora e segnala l'autonomia residua della batteria, permettendo di ottimizzare le ricariche ed effettuarle sempre in maniera corretta. È dotata di base di ricarica a contatto; caricabatterie non incluso.

Poldina micro is a rechargeable battery-powered cordless table lamp. A "touch" control on the head allows switching on/off, dimming, and selecting the color temperature of the light (2200K, 2700K or 3000K). It is suitable for both indoor and outdoor use (except gold and silver finishes). An electronic control system monitors the remaining autonomy and ensures a constant luminous flux until the battery runs out. Recharging is therefore optimized and always properly done. The lamp comes with a contact charging base; the battery charger is not included.

Dati tecnici Technical data

LED TOUCH DIMMER | 2200-2700-3000K | CRI>80 | 1,8W | 174-177-195lm |
IP65 | 5 Vdc max 1A

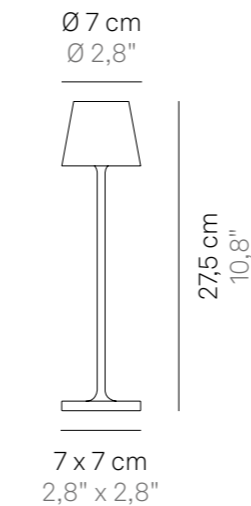

6,7 x 6,7 cm
2,6" x 2,6"

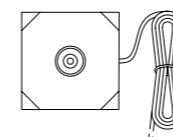

Componenti inclusi Components included

Base di ricarica a contatto
Contact charging base

Corpo in pressofusione di alluminio verniciato
Painted die-cast aluminum body

Schermo diffusore in policarbonato
Polycarbonate diffuser

Adatta all'uso esterno (lampada IP65) e interno (lampada su base di ricarica IP20)

Suitable for outdoor (lamp IP65) and indoor use (lamp on charging base IP20)

Durata di circa 7/8 h alla massima potenza
Battery lasts about 7/8 h at full power

Tempo di ricarica a 1A: 3 h
Charging time at 1A: 3 h

Pacco batteria al litio ricaricabile e sostituibile
Rechargeable and replaceable lithium battery pack

Avvertenze Remarks

Le lampade con finitura galvanica lucida oro e cromo non sono adatte per uso esterno.
The lamps with gold and chrome glossy galvanic finish are not suitable for outdoor use.

Accessori non inclusi Accessories not included

Caricabatterie 0
Charger



Current page:
Poldina micro table lamp white → **LD0490B3**

Next page: Poldina micro
table lamp glossy gold → **LD049003**
Poldina table lamp white → **LD0340B3**



Finiture
Finishes



LD0490B3
Bianco / White
RAL 9003



LD0490R3
Corten



LD0490N3
Grigio scuro / Dark gray



LD0490D3
Nero / Black
RAL 9004



LD0490S3
Sabbia / Sand



LD0490G3
Salvia / Sage green
Pantone 5635 U



LD0490P3
Rosa / Pink
Pantone 698 U



LD0490F3
Rosso / Red
RAL 3000



LD0490K3
Blu Capri / Capri blue
RAL 5019



LD0490L3
Lilla / Lilac
RAL 4005



LD0490V3
Verde mela / Apple green
RAL 6018



LD0490Z3
Arancio / Orange
RAL 2008

Finiture
Finishes



LD0490O3
Oro lucido
/ Glossy gold



LD0490C3
Cromo lucido
/ Glossy chrome



LD0490DFO
Nero - Foglia color oro
craquelé
/ Black - Gold color leaf
RAL 9004



LD0490KFO
Blu Capri - Foglia color
oro craquelé / Capi blue -
Gold color leaf craquelé
RAL 5019



LD0490FFO
Rosso - Foglia color oro
craquelé / Red - Gold
color leaf craquelé
RAL 3000

* Le lampade con finitura galvanica lucida oro e cromo e con le lampade con finitura craquelé non sono adatte per uso esterno.
* The lamps with gold and chrome glossy galvanic finish and the lamps with craquelé finish are not suitable for outdoor use.

Poldina L desk

Tavolo pro Table lamp pro

NEW



Poldina L desk è una lampada da tavolo a batteria, portatile e ricaricabile. Nella parte superiore della testa è presente un controllo "touch", che permette l'accensione, la regolazione dell'intensità luminosa e la selezione della temperatura di colore della luce tra 2200K, 2700K e 3000K. Grazie a un alto indice di protezione, la lampada è utilizzabile anche all'esterno. Possiede un sistema di controllo elettronico che monitora e segnala l'autonomia residua della batteria, permettendo di ottimizzare le ricariche ed effettuarle sempre in maniera corretta. È dotata di base di ricarica a contatto; caricabatterie incluso.

Poldina L desk is a rechargeable battery-powered cordless table lamp. A "touch" control on the head allows switching on/off, dimming, and selecting the color temperature of the light (2200K, 2700K or 3000K). It is suitable for both indoor and outdoor use. An electronic control system monitors the remaining autonomy and ensures a constant luminous flux until the battery runs out. Recharging is therefore optimized and always properly done. The lamp comes with a contact charging base; the battery charger is included.

Poldina L desk table
lamp dark grey → **LD0395N3**



Dati tecnici

Technical data

LED TOUCH DIMMER | 100-240V | 2200-2700-3000K | CRI>80 | 50-60Hz | 5,5W | 479- 540-550lm | **IP54** | 5Vdc max 1A



Corpo in pressofusione di alluminio verniciato

Painted die-cast aluminum body

Schermo diffusore in policarbonato

Polycarbonate diffuser

Adatta all'uso esterno (lampada IP54) e interno (lampada su base di ricarica IP20)

Suitable for outdoor (lamp IP54) and indoor use (lamp on charging base IP20)

Durata di circa 11 h alla massima potenza

Battery lasts about 11 h at full power

Tempo di ricarica a 1A: 11 h

Charging time at 1A: 11 h

Pacco batteria al litio ricaricabile e sostituibile

Rechargeable and replaceable lithium battery pack

Ø 16,5 cm
Ø 6,5"

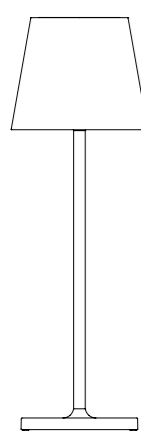

49,7 cm
19,6"

14 x 14 cm
5,5" x 5,5"

13,5 x 13,5 cm
5,3" x 5,3"

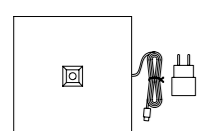
**Componenti inclusi**

Components included

Base di ricarica a contatto

Contact charging base

Caricabatterie

Charger

Finiture

Finishes

**LD0395B3**

Bianco / White

RAL 9003

LD0395R3

Corten

LD0395N3

Grigio scuro / Dark grey



Poldina L

Tavolo-terra pro Floor-table lamp pro

Poldina L è una lampada da terra e da tavolo a batteria, portatile e ricaricabile. Nella parte superiore della testa è presente un controllo "touch", che permette l'accensione, la regolazione dell'intensità luminosa e la selezione della temperatura di colore della luce tra 2200K, 2700K e 3000K. Grazie a un alto indice di protezione, la lampada è utilizzabile anche all'esterno. Possiede un sistema di controllo elettronico che monitora e segnala l'autonomia residua della batteria, permettendo di ottimizzare le ricariche ed effettuarle sempre in maniera corretta. È dotata di base di ricarica a contatto; caricabatterie incluso. È fornita con un kit di 3 aste che permette di configurarne l'altezza in tre misure: 52, 87 o 122 cm.



Poldina L is a rechargeable battery-powered cordless floor and table lamp. A "touch" control on the head allows switching on/off, dimming, and selecting the color temperature of the light (2200K, 2700K or 3000K). It is suitable for both indoor and outdoor use. An electronic control system monitors the remaining autonomy and ensures a constant luminous flux until the battery runs out. Recharging is therefore optimized and always properly done. The lamp comes with a contact charging base; the battery charger is included. It is provided with a 3-rod kit that allows to choose the height of the lamp among 52, 87 or 122 cm.

Poldina L floor-table lamp
white → **LD0390B3**



Dati tecnici

Technical data

LED TOUCH DIMMER | 100-240V | 2200-2700-3000K | CRI>80 | 50-60Hz | 5,5W | 479-540-550lm | **IP54** | 5Vdc max 1A



Ø 16,5 cm
Ø 6,5"

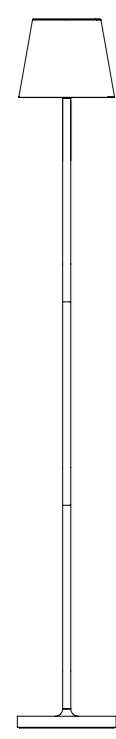

122 cm
48"

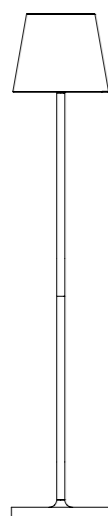

87 cm
34,2"

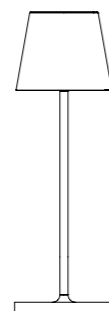

52 cm
20,4"

17 x 17 cm
6,6" x 6,6"

15 x 15 cm
5,9" x 5,9"

35 cm
13,8"

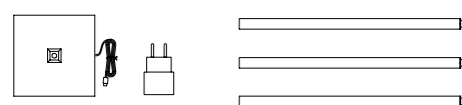

Corpo in pressofusione di alluminio verniciato
Painted die-cast aluminum body

Schermo diffusore in policarbonato
Polycarbonate diffuser

Adatta all'uso esterno (lampada IP54) e interno
(lampada su base di ricarica IP20)

Suitable for outdoor (lamp IP54) and indoor use
(lamp on charging base IP20)

Durata di circa 11 h alla massima potenza
Battery lasts about 11 h at full power

Tempo di ricarica a 1A: 11 h
Charging time at 1A: 11 h

Pacco batteria al litio ricaricabile e sostituibile
Rechargeable and replaceable lithium battery pack

Finiture

Finishes



LD0390B3
Bianco / White
RAL 9003



LD0390R3
Corten



LD0390N3
Grigio scuro / Dark grey

Componenti inclusi

Components included

Base di ricarica a contatto
Contact charging base

Caricabatterie
Charger

Stelo (3 pz.)
Stem (3 pcs.)

Poldina XXL

Tavolo-terra pro Floor-table lamp pro



Poldina XXL è una lampada da terra e da tavolo a batteria, portatile e ricaricabile. Nella parte superiore dello stelo è presente un controllo "touch", che permette l'accensione, la regolazione dell'intensità luminosa e la selezione della temperatura di colore della luce tra 2700K e 3000K. Grazie a un alto indice di protezione, la lampada è utilizzabile anche all'esterno. È dotata di base di ricarica a contatto; caricabatterie incluso. È fornita con un kit di 3 aste che permette di configurarne l'altezza in tre misure: 69, 110 o 150 cm.

Poldina XXL is a rechargeable battery-powered cordless floor and table lamp. A "touch" control on the upper part of the stem allows switching on/off, dimming, and selecting the color temperature of the light (2700K or 3000K). It is suitable for both indoor and outdoor use. The lamp comes with a contact charging base; the battery charger is included. It is provided with a 3-rod kit that allows to choose the height of the lamp among 69, 110 or 150 cm.



Poldina XXL floor-table lamp
dark grey → **LD0360N3**

Dati tecnici

Technical data

LED TOUCH DIMMER | 100-240V |
2700-3000K | CRI>80 | 50-60Hz | 6,5W |
470-500lm | **IP54** | 5Vdc max 1A



Ø 28 cm
Ø 11"

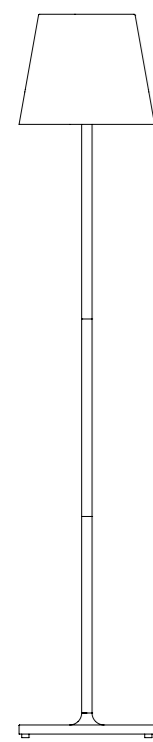

150 cm
59"

28 x 28 cm
11" x 11"

Ø 24,7 cm
Ø 9,7"

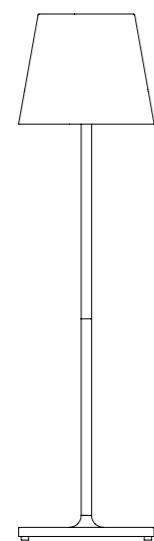
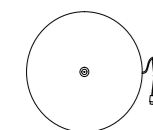

110 cm
43,3"

40 cm
15,7"

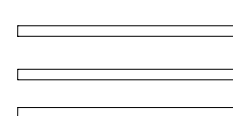

Corpo in pressofusione di alluminio verniciato
Painted die-cast aluminum body

Schermo diffusore in policarbonato
Polycarbonate diffuser

Adatta all'uso esterno (lampada IP54) e interno
(lampada su base di ricarica IP20)

Suitable for outdoor (lamp IP54) and indoor use
(lamp on charging base IP20)

Durata di circa 15 h alla massima potenza
Battery lasts about 15 h at full power

Tempo di ricarica a 1A: 20 h
Charging time at 1A: 20 h

Pacco batteria al litio ricaricabile e sostituibile
Rechargeable and replaceable lithium battery pack

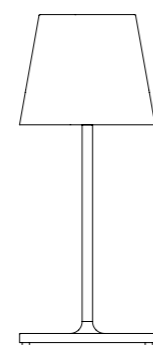

69,5 cm
27,3"

Componenti inclusi

Components included

Base di ricarica a contatto
Contact charging base

Caricabatterie
Charger

Stelo (3 pz.)
Stem (3 pcs.)

Finiture

Finishes



LD0360B3
Bianco / White
RAL 9003

LD0360R3
Corten

LD0360N3
Grigio scuro / Dark grey

Poldina

Picchetto pro

Lamp with peg pro



Poldina è una lampada a batteria, portatile e ricaricabile con picchetto. Nella parte superiore della testa è presente un controllo "touch", che permette l'accensione, la regolazione dell'intensità luminosa e la selezione della temperatura di colore della luce tra 2200K, 2700K e 3000K. Grazie a un alto indice di protezione, la lampada è utilizzabile anche all'esterno. Possiede un sistema di controllo elettronico che monitora e segnala l'autonomia residua della batteria, permettendo di ottimizzare le ricariche ed effettuarle sempre in maniera corretta. È dotata di testa magnetica che si rimuove in modo pratico e si ricarica comodamente sulla propria base di ricarica a contatto; caricabatterie incluso. È possibile personalizzare la lampada con cover in ceramica, acquistabili separatamente. Come accessori, sono disponibili aste aggiuntive che permettono di aumentare l'altezza della lampada.

Poldina is a rechargeable battery-powered cordless lamp with peg. A "touch" control on the head allows switching on/off, dimming, and selecting the color temperature of the light (2200K, 2700K or 3000K). It is suitable for both indoor and outdoor use. An electronic control system monitors the remaining autonomy and ensures a constant luminous flux until the battery runs out. Recharging is therefore optimized and always properly done. The lamp comes with magnetic head, which can be removed easily and recharged conveniently on their own contact charging base; the battery charger is included. It can be customized with a ceramic cover, to be purchased separately. Additional stem extensions are available as accessories to increase the height of the lamp (to be purchased separately).



Poldina lamp with peg white → **LD0682B3**

Dati tecnici

Technical data

LED TOUCH DIMMER | 100-240V | 2200-2700-3000K | CRI>80 | 50-60Hz | 2,2W | 234-251-256lm | **IP54** | 5Vdc max 1A



Corpo in pressofusione di alluminio verniciato

Painted die-cast aluminum body

Schermo diffusore in policarbonato

Polycarbonate diffuser

Adatta all'uso esterno (lampada IP54) e interno (lampada su base di ricarica IP20)

Suitable for outdoor (lamp IP54) and indoor use (lamp on charging base IP20)

Durata di circa 9 h alla massima potenza

Battery lasts about 9 h at full power

Tempo di ricarica a 1A: 6 h

Charging time at 1A: 6 h

Pacco batteria al litio ricaricabile e sostituibile

Rechargeable and replaceable lithium battery pack

Avvertenze

Remarks

La stabilità della lampada è garantita con l'uso di massimo tre prolunghe

The stability of the lamp is guaranteed when using three extensions maximum

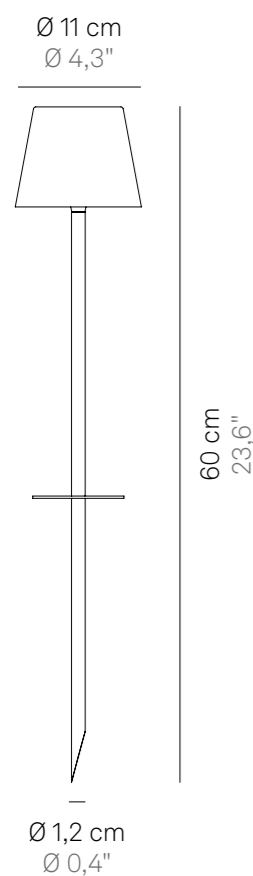

Ø 10,2 cm
Ø 4"

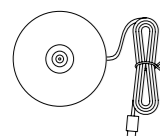
**Componenti inclusi**

Components included

Base di ricarica a contatto

Contact charging base

Accessori non inclusi

Accessories not included

Caricabatterie

Charger

Prolunga stelo aggiuntiva

Additional stem extension

Finiture

Finishes

**LD0682B3**

Bianco / White

RAL 9003

LD0682R3

Corten

LD0682N3

Grigio scuro / Dark grey

Prolunga stelo aggiuntiva (non inclusa)

Additional stem extension (not included)

25 cm
9,8"



25 cm
9,8"



25 cm
9,8"

**LD0283B3**

Bianco / White

RAL 9003

LD0283R3

Corten

LD0283N3

Grigio scuro / Dark grey

Poldina

Sospensione pro Suspension lamp pro



Poldina è una lampada a batteria, portatile e ricaricabile a sospensione. Nella parte superiore della testa è presente un controllo "touch", che permette l'accensione, la regolazione dell'intensità luminosa e la selezione della temperatura di colore della luce tra 2200K, 2700K e 3000K. Grazie a un alto indice di protezione, la lampada è utilizzabile anche all'esterno. Possiede un sistema di controllo elettronico che monitora e segnala l'autonomia residua della batteria, permettendo di ottimizzare le ricariche ed effettuarle sempre in maniera corretta. È dotata di testa magnetica che si rimuove in modo pratico e si ricarica comodamente sulla propria base di ricarica a contatto; caricabatterie incluso. È possibile personalizzare la lampada con cover in ceramica, acquistabili separatamente.

Poldina is a rechargeable battery-powered cordless suspension lamp. A "touch" control on the head allows switching on/off, dimming, and selecting the color temperature of the light (2200K, 2700K or 3000K). It is suitable for both indoor and outdoor use. An electronic control system monitors the remaining autonomy and ensures a constant luminous flux until the battery runs out. Recharging is therefore optimized and always properly done. The lamp comes with magnetic head, which can be removed easily and recharged conveniently on their own contact charging base; the battery charger is included. It can be customized with a ceramic cover, to be purchased separately.

Poldina suspension lamp
white → **LD0686B3**



Dati tecnici

Technical data

LED TOUCH DIMMER | 100-240V | 2200-2700-3000K | CRI>80 | 50-60Hz | 2,2W | 234-251-256lm | **IP54** | 5Vdc max 1A



Corpo in pressofusione di alluminio verniciato

Painted die-cast aluminum body

Schermo diffusore in policarbonato

Polycarbonate diffuser

Adatta all'uso esterno (lampada IP54) e interno (lampada su base di ricarica IP20)

Suitable for outdoor (lamp IP54) and indoor use (lamp on charging base IP20)

Durata di circa 9 h alla massima potenza

Battery lasts about 9 h at full power

Tempo di ricarica a 1A: 6 h

Charging time at 1A: 6 h

Pacco batteria al litio ricaricabile e sostituibile

Rechargeable and replaceable lithium battery pack

Ø 11 cm
Ø 4,3"

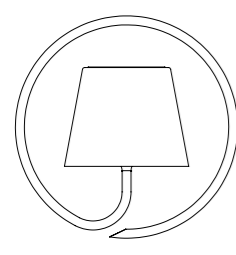

19,8 cm
7,8"

19,8 cm
7,8"

Ø 10,2 cm
Ø 4"

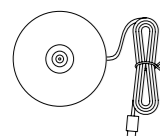
**Componenti inclusi**

Components included

Base di ricarica a contatto
Contact charging base

Accessori non inclusi

Accessories not included

Caricabatterie
Charger

Finiture

Finishes

**LD0686B3**

Bianco / White
RAL 9003

LD0686R3

Corten

LD0686N3

Grigio scuro / Dark grey



Poldina suspension lamp
corten → **LD0686R3**

Poldina

Parete pro Wall lamp pro



Poldina è una lampada a batteria, portatile e ricaricabile da parete, disponibile in due versioni. Nella parte superiore della testa è presente un controllo "touch", che permette l'accensione, la regolazione dell'intensità luminosa e la selezione della temperatura di colore della luce tra 2200K, 2700K e 3000K. Grazie a un alto indice di protezione, la lampada è utilizzabile anche all'esterno. Possiede un sistema di controllo elettronico che monitora e segnala l'autonomia residua della batteria, permettendo di ottimizzare le ricariche ed effettuarle sempre in maniera corretta. È dotata di testa magnetica che si rimuove in modo pratico e si ricarica comodamente sulla propria base di ricarica a contatto; caricabatterie incluso. È possibile personalizzare la lampada con cover in ceramica, acquistabili separatamente.

Poldina is a rechargeable battery-powered cordless wall lamp. A "touch" control on the head allows switching on/off, dimming, and selecting the color temperature of the light (2200K, 2700K or 3000K). It is suitable for both indoor and outdoor use. An electronic control system monitors the remaining autonomy and ensures a constant luminous flux until the battery runs out. Recharging is therefore optimized and always properly done. The lamp comes with magnetic head, which can be removed easily and recharged conveniently on their own contact charging base; the battery charger is included. It can be customized with a ceramic cover, to be purchased separately.



Poldina wall lamp dark grey
→ **LD0688N3**

Dati tecnici

Technical data

LED TOUCH DIMMER | 100-240V | 2200-2700-3000K | CRI>80 | 50-60Hz | 2,2W | 234-251-256lm | **IP54** | 5Vdc max 1A

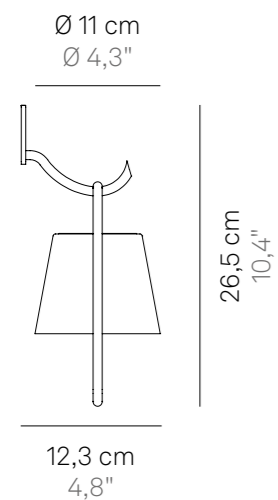
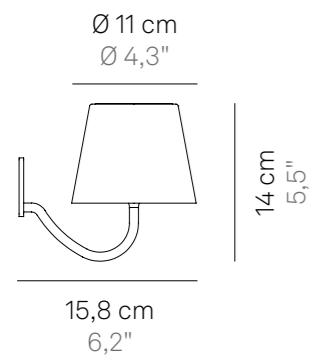

Ø 10,2 cm
Ø 4"

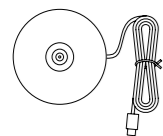

Componenti inclusi
Components included

Base di ricarica a contatto
Contact charging base

Corpo in pressofusione di alluminio verniciato
Painted die-cast aluminum body

Schermo diffusore in policarbonato
Polycarbonate diffuser

Adatta all'uso esterno (lampada IP54) e interno (lampada su base di ricarica IP20)

Suitable for outdoor (lamp IP54) and indoor use (lamp on charging base IP20)

Durata di circa 9 h alla massima potenza
Battery lasts about 9 h at full power

Tempo di ricarica a 1A: 6 h
Charging time at 1A: 6 h

Pacco batteria al litio ricaricabile e sostituibile
Rechargeable and replaceable lithium battery pack

Accessori non inclusi
Accessories not included

Caricabatterie
Charger

Finiture

Finishes



LD0688B3
Bianco / White
RAL 9003



LD0688R3
Corten



LD0688N3
Grigio scuro / Dark grey



LD0689B3
Bianco / White
RAL 9003



LD0689R3
Corten



LD0689N3
Grigio scuro / Dark grey

Poldina

Cover in ceramica made in Italy

Ceramic cover made in Italy

NEW

Accessorio per / Accessory for:
 Poldina table lamp
 Poldina mini table lamp
 Poldina lamp with peg
 Poldina suspension lamp
 Poldina wall lamp
 Poldina Reverso table lamp



Dati tecnici

Technical data

CE

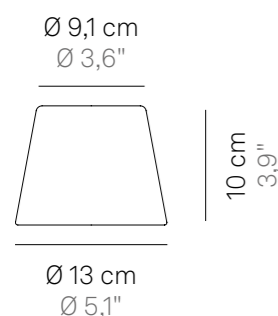

Componenti inclusi
 Components included

Adesivo
 Adhesive

Video tutorial: montaggio cover
 Tutorial video: installation of the cover



Cover in ceramica che si fissa alla testa della lampada Poldina tramite adesivi. La stretta collaborazione con un'antica fabbrica di Civita Castellana - borgo viterbese dove l'arte della ceramica è attestata fin dal X secolo a.C. – consente a Zafferano di avvalersi di una produzione esclusiva di manufatti “Made in Italy”, decorati a mano su disegno proprio o del cliente.

Ceramic cover that is fixed to the head of the lamp with adhesive strips. The close partnership with a historic factory in Civita Castellana - a village near Rome, where the art of ceramics has been practiced since the 10th century BC - allows Zafferano to rely on the exclusive production of made in Italy artifacts, which are hand-painted according to Zafferano design; customization available.

Finiture

Finishes



LD035000
 Righe verdi
 Green stripes



LD035001
 Righe gialle
 Yellow stripes



LD035002
 Righe blu
 Blue stripes



LD035003
 Righe rosse
 Red stripes



LD035004
 Pesci azzurri
 Light blue fish



Poldina table lamp Avio blue → LD0340A3
 Ceramic cover → LD035004



Poldina wall lamp white + ceramic cover
→ **LD0340B3 + LD035000**



Poldina Reverso

Design Federico de Majo

Come sono belli e delicati
i piccoli fiori del tuo davanzale.
Se illuminati i loro colori
si trasformano in cristalli: dolci e salati,
diventano un piccolo tesoro
o le chiavi della felicità.

What beautiful, tiny and
delicate flowers on your windowsill.
When illuminated their colours
turn into crystals: sweet and savoury,
they become a little treasure
or the keys to happiness.

TAVOLO
TABLE LAMP



Poldina Reverso table
lamp white → **LD0420B3**
Porto Caleri
Rovigo, Italy

Poldina Reverso

Tavolo pro Table lamp pro

NEW



Video Poldina Reverso



Poldina Reverso è una lampada da tavolo a batteria, portatile e ricaricabile, con contenitore multiuso. Nella parte inferiore della testa è presente un controllo "touch", che permette l'accensione, la regolazione dell'intensità luminosa e la selezione della temperatura di colore della luce tra 2200K, 2700K e 3000K. Grazie a un alto indice di protezione, la lampada è utilizzabile anche all'esterno. Il contenitore multiuso (capacità 18 cl) in resina termoplastica adatta al contatto alimentare (PET) è removibile e riutilizzabile. Possiede un sistema di controllo elettronico che monitora e segnala l'autonomia residua della batteria, permettendo di ottimizzare le ricariche ed effettuarle sempre in maniera corretta. È dotata di base di ricarica a contatto; caricabatterie incluso. È possibile personalizzare la lampada con cover in ceramica, acquistabili separatamente

Poldina Reverso is a rechargeable battery-powered cordless table lamp, with a multipurpose storage tray. A "touch" control smartly placed on the lower part of the head allows switching on/off, dimming, and selecting the color temperature of the light (2200K, 2700K or 3000K). It is suitable for both indoor and outdoor use. The multipurpose container tray (capacity 18cl) in thermoplastic resin suitable for food contact (PET) is removable and reusable. An electronic control system monitors the remaining autonomy and ensures a constant luminous flux until the battery runs out. Recharging is therefore optimized and always properly done. The lamp comes with a contact charging base; battery charger included. Poldina Reverso can be customized with a ceramic cover, to be purchased separately

Poldina Reverso table lamp
white → LD0420B3







Poldina Reverso table lamp
sage green → **LD0420G3**



Poldina Reverso table lamp
dark grey → **LD0420N3**



Pulsante touch per l'accensione e dimmerazione
Touch switch for on/off and dimming

Vaschetta contenitore multiuso
(adatto anche per uso alimentare)
Multipurpose container tray (suitable also for food)
→ **LD0420V1**



Poldina Reverso table
lamp corten → **LD0420R3**



Dati tecnici

Technical data

LED TOUCH DIMMER | 100-240V | 2200-2700-3000K | CRI>80 | 50-60Hz | 2,3W | 241-250-262lm | **IP54** | 5Vdc max 1A

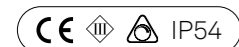

Corpo in pressofusione di alluminio verniciato

Painted die-cast aluminum body

Schermo diffusore in policarbonato satinato

Diffuser in satin-finish polycarbonate

Adatta all'uso esterno (lampada IP54) e interno (lampada su base di ricarica IP20)

Suitable for outdoor (lamp IP54) and indoor use (lamp on charging base IP20)

Durata di circa 12 h alla massima potenza

Battery lasts about 12 h at full power

Tempo di ricarica a 1A: 6/7 h

Charging time at 1A: 6/7 h

Pacco batteria al litio ricaricabile e sostituibile

Rechargeable and replaceable lithium battery pack

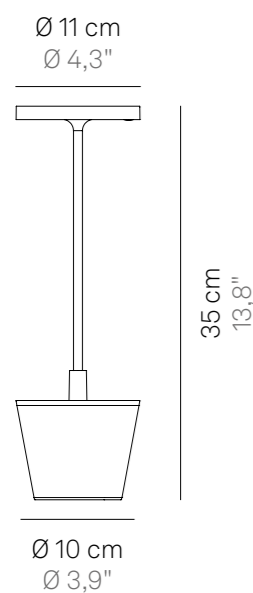

Ø 7,5 cm
Ø 2,9"

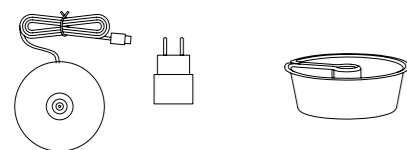
**Componenti inclusi**

Components included

Base di ricarica a contatto

Contact charging base

Caricabatterie

Charger

Vaschetta contenitore multiuso

Multipurpose container tray

Finiture

Finishes

**LD0420B3**

Bianco / White
RAL 9003

**LD0420R3**

Corten

**LD0420N3**

Grigio scuro / Dark grey

**LD0420S3**

Sabbia / Sand

**LD0420G3**

Salvia / Sage green
Pantone 5635 U

Poldina

Stopper



Poldina è una lampada a batteria, portatile e ricaricabile, con tappo in silicone, che si può inserire su una bottiglia, trasformandola in un oggetto luminoso. Nella parte superiore della testa è presente un controllo "touch", che permette l'accensione, la regolazione dell'intensità luminosa e la selezione della temperatura di colore della luce tra 2200K, 2700K e 3000K. Grazie a un alto indice di protezione, la lampada è utilizzabile anche all'esterno. Possiede un sistema di controllo elettronico che monitora e segnala l'autonomia residua della batteria, permettendo di ottimizzare le ricariche ed effettuarle sempre in maniera corretta. Il tappo in silicone (adatto al contatto alimentare) si adatta a diversi colli di bottiglia e si rimuove in modo pratico, permettendo di ricaricare comodamente la lampada sulla propria base di ricarica a contatto; caricabatterie non incluso. Poldina Stopper è utilizzabile anche con le bottiglie in ceramica "Lido", acquistabili separatamente.

Poldina is a rechargeable battery-operated, cordless lamp. Thanks to a silicone stopper cork, the lamp can be placed on a bottle, turning it into a luminous object. A "touch" control on the head allows switching on/off, dimming, and selecting the color temperature of the light (2200K, 2700K, or 3000K). It is suitable for both indoor and outdoor use. An electronic control system monitors the remaining autonomy and ensures a constant luminous flux until the battery runs out. Recharging is therefore optimized and always properly done. The silicone cap (suitable for food contact) fits different bottle necks and can be easily removed, allowing the lamp to be conveniently recharged on its contact charging base; battery charger not included. Poldina Stopper can also be used with "Lido" ceramic bottles, which can be purchased separately.



Poldina Stopper black → **LD0349D3**
Lido ceramic bottle black → **FAS1508**



Poldina Stopper black → **LD0349D3**
Lido ceramic bottle black → **FAS1508**

Poldina Stopper sand → **LD0349S3**
Lido ceramic bottle sand → **FAS1507 + PUN1507**



Dati tecnici

Technical data

LED TOUCH DIMMER

2200-2700-3000 K | CRI>80
234-251-256 lm | 2,2 W | IP54
5 Vdc max 1A



Ø 2,5 x 3,8 cm
Ø 1 x 1,5 in

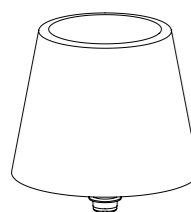

Ø 11,1 x 11,1 cm
Ø 4,4 x 4,4 in

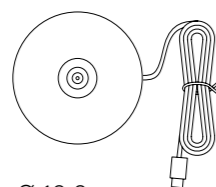

Ø 10,2 cm
Ø 4 in

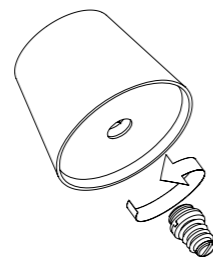

Corpo in pressofusione di alluminio verniciato
Painted die-cast aluminum body

Schermo diffusore in policarbonato
Polycarbonate diffuser

Tappo in silicone
Silicon cover

Adatta all'uso esterno (lampada IP54) e interno
Suitable for outdoor (lamp IP54) and indoor use

Durata di circa 12 h alla massima potenza
Battery lasts about 12 h at full power

Tempo di ricarica a 1A: 6/7 h
Charging time at 1A: 6/7 h

Pacco batteria al litio ricaricabile e sostituibile
Rechargeable and replaceable lithium battery pack

Finiture

Finishes



LD0349B3
Bianco / White
RAL 9003



LD0349A3
Blu avio / Avio blue
Pantone 7468 U



LD0349F3
Rosso / Red
RAL 3000



LD0349G3
Salvia / Sage green
Pantone 5635 U



LD0349S3
Sabbia / Sand



LD0349D3
Nero / Black
RAL 9004

Componenti inclusi

Components included

Base di ricarica a contatto
Contact charging base

Tappo in silicone per Poldina / Poldina silicon cover

Accessori non inclusi

Accessories not included

Caricatore / Charger
100-240 V | USB Type A
LD0490UA



Poldina Stopper Avio blue → **LD0349A3**
Lido ceramic bottle light blue → **RIG1508**

Lido

Design Federico de Majo

Bottiglia in ceramica Ceramic bottle



Bottiglia in ceramica, nella cui imboccatura si può alloggiare la lampada Poldina Stopper.

È prodotta in tre modelli, diversi tra loro per forma e motivo decorativo; ciascun modello è disponibile in cinque colori, con tappo sferico in tinta.

La stretta collaborazione con un'antica fabbrica di Civita Castellana – borgo viterbese dove l'arte della ceramica è attestata fin dal X secolo a.C. – consente a Zafferano di avvalersi di una produzione esclusiva di manufatti "Made in Italy", decorati a mano su disegno proprio.

Ceramic bottle in whose mouth the Poldina Stopper lamp can be placed.

It is produced in three models, different in shape and decorative motif; each model is available in five colors, with matching spherical cap.

The close collaboration with an ancient factory in Civita Castellana, a village in the Viterbo area where the art of ceramics has been attested since the 10th century B.C., allows Zafferano to take advantage of an exclusive production of "Made in Italy" artifacts, hand-decorated according to its own design.



Lido ceramic bottle green → FAS1505

Dati tecnici

Technical data

Ceramica decorata a mano
Hand-painted ceramic

Tappo ermetico, in materiale plastico,
adatto al contatto alimentare
Airtight plastic stopper, suitable for
food contact

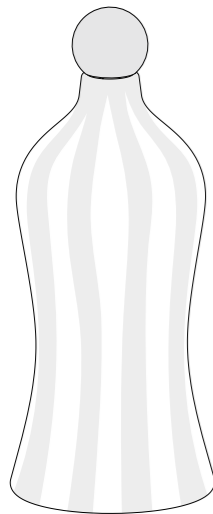
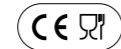

Ø 11 x 26,5 cm
Ø 4,3 x 10,4 in
90 cl

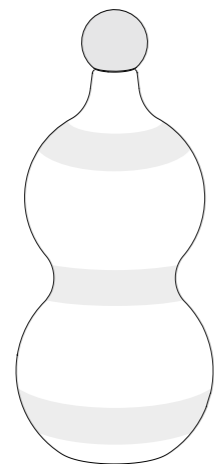

Ø 10,4 x 24,5 cm
Ø 4,1 x 9,6 in
82 cl

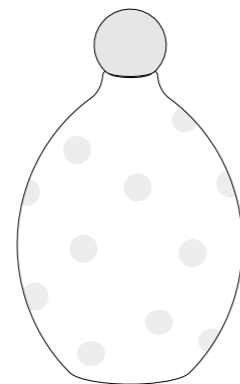

Ø 13 x 20,5 cm
Ø 5,1 x 8,1 in
114 cl



Finiture

Finishes



RIG1501
Righe azzurre
Light blue stripes



RIG1502
Righe rosse
Red stripes



RIG1505
Righe verdi
Green stripes



RIG1507
Righe sabbia
Sand stripes



RIG1508
Righe nere
Black stripes



FAS1501
Fasce azzurre
Light blue bands



FAS1502
Fasce rosse
Red bands



FAS1505
Fasce verdi
Green bands



FAS1507
Fasce sabbia
Sand bands



FAS1508
Fasce nere
Black bands



PUN1501
Pois azzurri
Light blue dots



PUN1502
Pois rossi
Red dots



PUN1505
Pois verdi
Green dots



PUN1507
Pois sabbia
Sand dots



PUN1508
Pois neri
Black dots

Ofelia

Edera, forte, intensa
Giunte dopo un lungo errare
Uniamo le nostre radici
In un intimo cercarsi.

Ivy, strong and intense
arriving after a long ramble
we merge our roots
in an intimate search.

TAVOLO / MICROTAVOLO
TABLE LAMP / MICRO TABLE LAMP



Ofelia table lamp white
→ **LD1870B3**
Storga river springs
Treviso, Italy



Ofelia table lamp sage
green → **LD1870G3**
Ristorante Piastrino *
Pennabilli, Italy
Photo Marco Poderi Studio

Ofelia table lamp
sand → **LD1870S3**
Ristorante Oltre
Leporano, Italy
Photo Giuseppe Musolino



Ofelia

Tavolo pro Table lamp pro



Ofelia è una lampada da tavolo a batteria, portatile e ricaricabile. Nella parte superiore della testa è presente un controllo "touch", che permette l'accensione, la regolazione dell'intensità luminosa e la selezione della temperatura di colore della luce tra 2200K, 2700K e 3000K. Ofelia possiede inoltre la funzione di memoria dell'impostazione di dimmerazione, che memorizza gli step di dimmerazione: di conseguenza, ad ogni accensione, l'intensità luminosa corrisponderà a quella precedentemente impostata. Grazie a un alto indice di protezione, la lampada è utilizzabile anche all'esterno. È dotata di base di ricarica a contatto; caricabatterie incluso.

Ofelia is a rechargeable battery-powered cordless table lamp. A "touch" control on the head allows switching on/off, dimming, and selecting the color temperature of the light (2200K, 2700K or 3000K). Ofelia is equipped with the dimmer memory function, which adjusts the light intensity and memorizes the dimmer steps; consequently, every time it is switched on, the light intensity will correspond to that previously set. It is suitable for both indoor and outdoor use. The lamp comes with a contact charging base; battery charger included.

Ofelia table lamp sage green
→ LD1870G3



Dati tecnici

Technical data

LED TOUCH DIMMER | 100-240V |
2200-2700-3000K | CRI>80 | 50-60Hz |
2,2W | 231-244-252lm | **IP65** | 5Vdc max 1A



Corpo in pressofusione di alluminio verniciato

Painted die-cast aluminum body

Schermo diffusore in policarbonato prismatico

Prismatic polycarbonate diffuser

Adatta all'uso esterno (lampada IP65) e interno
(lampada su base di ricarica IP20)

Suitable for outdoor (lamp IP65) and indoor use
(lamp on charging base IP20)

Durata di circa 9 h alla massima potenza

Battery lasts about 9 h at full power

Tempo di ricarica a 1A: 6 h

Charging time at 1A: 6 h

Pacco batteria al litio ricaricabile e sostituibile

Rechargeable and replaceable lithium battery pack

10 x 10 cm
3,9 x 3,9"

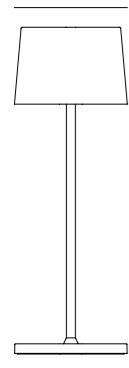

29 cm
11,4"

10 x 10 cm
3,9" x 3,9"

11,6 x 11,6 cm
4,5" x 4,5"

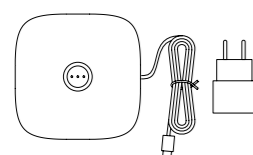
**Componenti inclusi**

Components included

Base di ricarica a contatto

Contact charging base

Caricabatterie

Charger

Finiture

Finishes

**LD1870B3**

Bianco / White

RAL 9016

**LD1870R3**

Corten

**LD1870N3**

Grigio scuro / Dark grey

RAL 7024

**LD1870S3**

Sabbia / Sand

RAL 1014

**LD1870G3**

Salvia / Sage green

Pantone 5635U

Ofelia micro

Tavolo pro

Table lamp pro



Ofelia micro è una lampada da tavolo a batteria, portatile e ricaricabile. Nella parte superiore della testa è presente un controllo "touch", che permette l'accensione, la regolazione dell'intensità luminosa e la selezione della temperatura di colore della luce tra 2200 K, 2700 K e 3000 K. Ofelia micro possiede inoltre la funzione di memoria dell'impostazione di dimmerazione, che memorizza gli step di dimmerazione. Grazie a un alto indice di protezione, la lampada è utilizzabile anche all'esterno. È dotata di base di ricarica a contatto; caricabatterie incluso.

Ofelia micro is a rechargeable battery-powered cordless table lamp. A "touch" control on the head allows switching on/off, dimming, and selecting the color temperature of the light (2200 K, 2700 K or 3000 K). Ofelia micro is equipped with the dimmer memory function, which adjusts the light intensity and memorizes the dimmer steps. It is suitable for both indoor and outdoor use. The lamp comes with a contact charging base; battery charger included.



Ofelia micro table lamp corten → **LD1880R3**
Ofelia micro table lamp sand → **LD1880S3**

Dati tecnici

Technical data

LED TOUCH DIMMER

2200-2700-3000 K | CRI>80
183-195-216 lm | 2,2 W | IP65
5 Vdc max 1A



Corpo in pressofusione di alluminio verniciato
Painted die-cast aluminum body

Schermo diffusore in policarbonato
Polycarbonate diffuser

Adatta all'uso esterno (lampada IP65) e interno
(lampada su base di ricarica IP20)
Suitable for outdoor (lamp IP65) and indoor use
(lamp on charging base IP20)

Durata di circa 9 h alla massima potenza
Battery lasts about 9 h at full power

Tempo di ricarica a 1A: 4,5 h
Charging time at 1A: 4,5 h

Pacco batteria al litio ricaricabile e sostituibile
Rechargeable and replaceable lithium battery pack

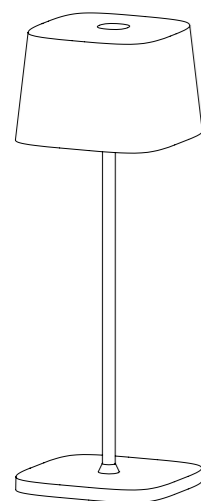

6,7 x 6,7 x 20 cm
2,6 x 2,6 x 7,9 in

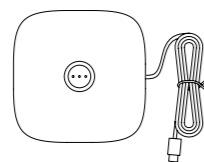

7,1 x 7,1 cm
2,8 x 2,8 in

Componenti inclusi

Components included

Base di ricarica a contatto
Contact charging base

Accessori non inclusi

Accessories not included

Caricatore / Charger
100-240 V | USB Type A
LD0490UA

Finiture

Finishes



LD1880B3
Bianco / White
RAL 9016



LD1880R3
Corten



LD1880N3
Grigio scuro
/ Dark gray
RAL 7024



LD1880S3
Sabbia / Sand
RAL 1014



LD1880G3
Salvia / Sage green
Pantone 5635 U



Olivia

We are the custodians
of a pure stone manor
with its strong presence
and hard, rugged rock.
Illuminated, it is softened
and when night falls
we keep vigil motionless.

Siamo custodi
di un maniero di pura pietra
forte presenza
roccia dura ed aspra.
Illuminata si addolcisce
scesa la notte
vegliamo immobili.

TAVOLO / MINI TAVOLO / MICRO TAVOLO
TABLE LAMP / MINI TABLE LAMP / MICRO TABLE LAMP



Olivia table lamp white
→ **LD0850B3**
Caglieron Caves
Treviso, Italy



Olivia table lamp
corten → **LD0850R3**
A Cavalariça
Évora, Portugal
Photo Francisco Nogueira



Olivia mini table lamp orange → **LD0860Z3**
Olivia mini table lamp Capri blue → **LD0860K3**
Olivia mini table lamp apple green → **LD0860V3**

Olivia

Tavolo pro Table lamp pro



Olivia è una lampada da tavolo a batteria, portatile e ricaricabile. Nella parte superiore della testa è presente un controllo "touch", che permette l'accensione, la regolazione dell'intensità luminosa e la selezione della temperatura di colore della luce tra 2700K e 3000K. Olivia possiede inoltre la funzione di memoria dell'impostazione di dimmerazione, che memorizza gli step di dimmerazione: di conseguenza, ad ogni accensione, l'intensità luminosa corrisponderà a quella precedentemente impostata. Grazie a un alto indice di protezione, la lampada è utilizzabile anche all'esterno (ad eccezione dei modelli con finitura a foglia metallica, delle quali è sconsigliato l'uso continuativo in esterni). È dotata di base di ricarica a contatto; caricabatterie incluso.

Olivia is a rechargeable battery-powered cordless table lamp. A "touch" control on the head allows switching on/off, dimming, and selecting the color temperature of the light (2700K or 3000K). Olivia is equipped with the dimmer memory function, which adjusts the light intensity and memorizes the dimmer steps; consequently, every time it is switched on, the light intensity will correspond to that previously set. It is suitable for both indoor and outdoor use (except gold, silver and copper finishes). The lamp comes with a contact charging base; battery charger included.



Olivia table lamp corten → LD0850R3

Dati tecnici

Technical data

LED TOUCH DIMMER | 100-240V |
2700-3000K | CRI>80 | 50-60Hz | 2,2W |
245-262lm | **IP65** | 5Vdc max 1A



Corpo in pressofusione di alluminio verniciato

Painted die-cast aluminum body

Schermo diffusore in policarbonato prismatico

Prismatic polycarbonate diffuser

Adatta all'uso esterno (lampada IP65) e interno
(lampada su base di ricarica IP20)

Suitable for outdoor (lamp IP65) and indoor use
(lamp on charging base IP20)

Durata di circa 9 h alla massima potenza

Battery lasts about 9 h at full power

Tempo di ricarica a 1A: 6 h

Charging time at 1A: 6 h

Pacco batteria al litio ricaricabile e sostituibile

Rechargeable and replaceable lithium battery pack

Avvertenze

Remarks

Le lampade con finitura foglia color oro, foglia color argento e foglia color rame non sono adatte per uso esterno.

The lamps with gold color leaf, silver color leaf and copper color leaf finish are not suitable for outdoor use.

Per effetto della natura manuale della tecnica adottata nella lavorazione con foglia metallica, l'aspetto finale della finitura delle lampade può risultare differente. Eventuali difformità attestano il pregio e l'unicità di ciascuna lampada e non vanno considerate come imperfezioni.

Due to the manual nature of the technique adopted in the application of the metal foil, the final appearance of the lamps' finishing can be different. Any apparent imperfections attest to the quality and exclusivity of each lamp and should not be considered as imperfections.

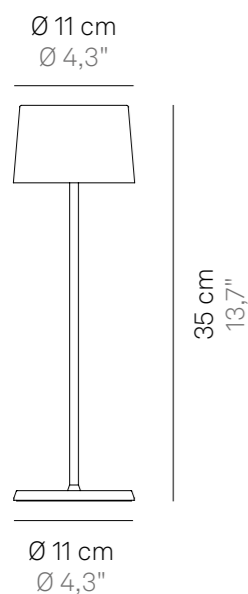

Ø 11,6 cm
Ø 4,5"

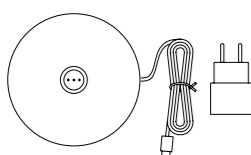
**Componenti inclusi**

Components included

Base di ricarica a contatto

Contact charging base

Caricabatterie

Charger

Finiture

Finishes

**LD0850B3**

Bianco / White
RAL 9016

**LD0850R3**

Corten

**LD0850N3**

Grigio scuro / Dark grey
RAL 7012

**LD0850BFO ***

Foglia color oro
/ Gold color leaf

**LD0850BFA ***

Foglia color argento
/ Silver color leaf

**LD0850RFR ***

Foglia color rame
/ Copper color leaf

* Le lampade con finitura foglia color oro, foglia color argento e foglia color rame non sono adatte per uso esterno.

* The lamps with gold color leaf, silver color leaf and copper color leaf finish are not suitable for outdoor use.

Olivia mini

Tavolo pro

Table lamp pro



Olivia mini è una lampada da tavolo a batteria, portatile e ricaricabile. Nella parte superiore della testa è presente un controllo "touch", che permette l'accensione, la regolazione dell'intensità luminosa e la selezione della temperatura di colore della luce tra 2700K e 3000K. Olivia mini possiede inoltre la funzione di memoria dell'impostazione di dimmerazione, che memorizza gli step di dimmerazione: di conseguenza, ad ogni accensione, l'intensità luminosa corrisponderà a quella precedentemente impostata. Grazie a un alto indice di protezione, la lampada è utilizzabile anche all'esterno. È dotata di base di ricarica a contatto; caricabatterie incluso.

Olivia mini is a rechargeable battery-powered cordless table lamp. A "touch" control on the head allows switching on/off, dimming, and selecting the color temperature of the light (2700K or 3000K). Olivia mini is equipped with the dimmer memory function, which adjusts the light intensity and memorizes the dimmer steps; consequently, every time it is switched on, the light intensity will correspond to that previously set. It is suitable for both indoor and outdoor use. The lamp comes with a contact charging base; battery charger included.



Olivia mini table lamp corten
→ **LD0860R3**

Dati tecnici

Technical data

LED TOUCH DIMMER | 100-240V |
2700-3000K | CRI>80 | 50-60Hz | 2,2W |
245-262lm | **IP65** | 5Vdc max 1A



Corpo in pressofusione di alluminio verniciato

Painted die-cast aluminum body

Schermo diffusore in policarbonato prismatico

Prismatic polycarbonate diffuser

Adatta all'uso esterno (lampada IP65) e interno
(lampada su base di ricarica IP20)

Suitable for outdoor (lamp IP65) and indoor use
(lamp on charging base IP20)

Durata di circa 9 h alla massima potenza

Battery lasts about 9 h at full power

Tempo di ricarica a 1A: 6 h

Charging time at 1A: 6 h

Pacco batteria al litio ricaricabile e sostituibile

Rechargeable and replaceable lithium battery pack

Ø 11 cm
Ø 4,3"

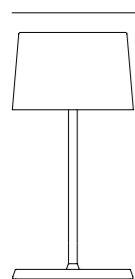

22 cm
8,7"

Ø 11 cm
Ø 4,3"

Ø 11,6 cm
Ø 4,5"

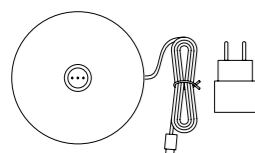
**Componenti inclusi**

Components included

Base di ricarica a contatto

Contact charging base

Caricabatterie

Charger

Finiture

Finishes

**LD0860B3**

Bianco / White
RAL 9016

**LD0860R3**

Corten

**LD0860N3**

Grigio scuro / Dark grey
RAL 7012

**LD0860K3**

Blu Capri / Capri blue
RAL 5019

**LD0860L3**

Lilla / Lilac
RAL 4005

**LD0860V3**

Verde mela / Apple green
RAL 6018

**LD0860Z3**

Arancio / Orange
RAL 2008

Olivia micro

Tavolo pro

Table lamp pro



Olivia micro è una lampada da tavolo a batteria, portatile e ricaricabile. Nella parte superiore della testa è presente un controllo "touch", che permette l'accensione, la regolazione dell'intensità luminosa e la selezione della temperatura di colore della luce tra 2200 K, 2700 K e 3000 K. Olivia micro possiede inoltre la funzione di memoria dell'impostazione di dimmerazione, che memorizza gli step di dimmerazione. Grazie a un alto indice di protezione, la lampada è utilizzabile anche all'esterno. È dotata di base di ricarica a contatto; caricabatterie incluso.

Olivia micro is a rechargeable battery-powered cordless table lamp. A "touch" control on the head allows switching on/off, dimming, and selecting the color temperature of the light (2200 K, 2700 K or 3000 K). Olivia micro is equipped with the dimmer memory function, which adjusts the light intensity and memorizes the dimmer steps; consequently, every time it is switched on, the light intensity will correspond to that previously set. It is suitable for both indoor and outdoor use. The lamp comes with a contact charging base; battery charger included.



Olivia micro table lamp
white → LD1840B3

Dati tecnici

Technical data

LED TOUCH DIMMER

2200-2700-3000 K | CRI>80
183-187-225 lm | 2,2 W | IP65
5 Vdc max 1A



Corpo in pressofusione di alluminio verniciato
Painted die-cast aluminum body

Schermo diffusore in policarbonato
Polycarbonate diffuser

Adatta all'uso esterno (lampada IP65) e interno
(lampada su base di ricarica IP20)
Suitable for outdoor (lamp IP65) and indoor use
(lamp on charging base IP20)

Durata di circa 9 h alla massima potenza
Battery lasts about 9 h at full power

Tempo di ricarica a 1A: 4,5 h
Charging time at 1A: 4,5 h

Pacco batteria al litio ricaricabile e sostituibile
Rechargeable and replaceable lithium battery pack

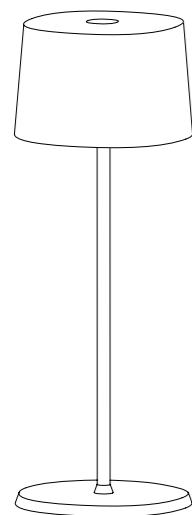

Ø 7,5 x 20 cm
Ø 2,9 x 7,9 in

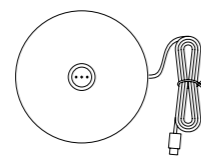

Ø 7,9 cm
Ø 3,1 in

Componenti inclusi

Components included

Base di ricarica a contatto
Contact charging base

Accessori non inclusi

Accessories not included

Caricatore / Charger
100-240 V | USB Type A
LD0490UA

Finiture

Finishes



LD1840B3
Bianco / White
RAL 9016



LD1840R3
Corten



LD1840N3
Grigio scuro / Dark gray
RAL 7012



LD1840S3
Sabbia / Sand
RAL 1014



Olivia table lamp dark gray → **LD0850N3**
Olivia mini table lamp dark gray → **LD0860N3**
Olivia micro table lamp dark gray → **LD1840N3**

Pina

Piccola, docile
mobile e leggera
ti annidi e ti confondi.
Gioca la luce
offre dettagli dimenticati.

Small, gentle
mobile and light
you hide and blend in.
Light brings playful effects
offering forgotten details.

TAVOLO / SUPPORTO DA TERRA / VASSOIO IN CERAMICA
TABLE LAMP / FLOOR STAND / CERAMIC TRAY



Pina table lamp white → **LD1650B3**
Morgano countryside
Treviso, Italy



Previous page: Pina table lamp corten →
LD1650R3
 Cipriani Club 55 - New York City, USA

Current page: Pina table lamp corten →
LD1650R3
 Cipriani Downtown - New York City, USA
 Photo Kathi Littwin Photography



Pina table lamp
black - gold color leaf craquelé → **LD1650DFO**



Pina table lamp
gold color leaf → **LD1650BFO**

Pina

Tavolo pro Table lamp pro



Pina nel New York Times
Pina in New York Times



Pina è una lampada da tavolo a batteria, portatile e ricaricabile. Sulla base è presente un controllo "touch", che permette l'accensione, la regolazione dell'intensità luminosa e la selezione della temperatura di colore della luce tra 2200K, 2700K e 3000K. Grazie a un alto indice di protezione, la lampada è utilizzabile anche all'esterno (ad eccezione dei modelli con finitura a foglia metallica, delle quali è sconsigliato l'uso continuativo in esterni). Possiede un sistema di controllo elettronico che monitora e segnala l'autonomia residua della batteria, permettendo di ottimizzare le ricariche ed effettuarle sempre in maniera corretta. È dotata di base di ricarica a contatto; caricabatterie incluso. Pina è personalizzabile con il supporto da terra o con il vassoio in ceramica, acquistabili separatamente.

Pina is a rechargeable battery-powered cordless table lamp. A "touch" control on the base allows switching on/off, dimming, and selecting the color temperature of the light (2200 K, 2700 K or 3000 K). It is suitable for both indoor and outdoor use (except gold, silver and copper finishes). An electronic control system monitors the remaining autonomy and ensures a constant luminous flux until the battery runs out. Recharging is therefore optimized and always properly done. The lamp comes with a contact charging base; battery charger included. Pina can be accessorized with a floor stand or a ceramic tray, to be purchased separately.

Pina table lamp white
→ LD1650B3



Dati tecnici

Technical data

LED TOUCH DIMMER | 2200-2700-3000K | CRI>80 | 2,2W | 178-204-206lm | **IP54** | 5Vdc max 1A | 50-60Hz | 100-240V



Corpo in pressofusione di alluminio verniciato

Painted die-cast aluminum body

Schermo diffusore in policarbonato

Polycarbonate diffuser

Adatta all'uso esterno (lampada IP54) e interno (lampada su base di ricarica IP20)

Suitable for outdoor (lamp IP54) and indoor use (lamp on charging base IP20)

Durata di circa 12 h alla massima potenza

Battery lasts about 12 h at full power

Tempo di ricarica a 1A: 6/7 h

Charging time at 1A: 6/7 h

Pacco batteria al litio ricaricabile e sostituibile

Rechargeable and replaceable lithium battery pack

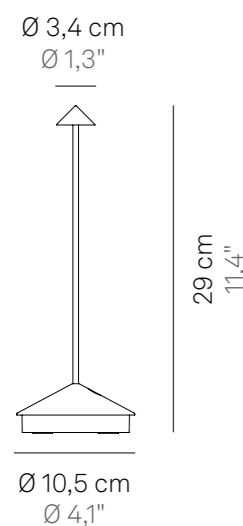

Avvertenze

Remarks

Le lampade con finitura foglia color oro, foglia color argento, foglia color rame e con finitura craquelé non sono adatte per uso esterno.

The lamps with gold color leaf, silver color leaf and copper color leaf finish and the lamp with craquelé finish are not suitable for outdoor use.

Per effetto della natura manuale della tecnica adottata nella lavorazione con foglia metallica, l'aspetto finale della finitura delle lampade può risultare differente. Eventuali difformità attestano il pregio e l'unicità di ciascuna lampada e non vanno considerate come imperfezioni.

Due to the manual nature of the technique adopted in the application of the metal foil, the final appearance of the lamps' finishing can be different. Any apparent imperfections attest to the quality and exclusivity of each lamp and should not be considered as imperfections.

Ø 7,5 cm
Ø 2,9"

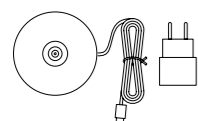

Componenti inclusi

Components included

Base di ricarica a contatto

Contact charging base

Caricabatterie / Charger

100-240 V | Type A

Finiture

Finishes



LD1650B3

Bianco / White
RAL 9003

LD1650R3

Corten

LD1650N3

Grigio scuro / Dark gray

LD1650D3

Nero / Black
RAL 9004

LD1650S3

Sabbia / Sand



LD1650BFO

Foglia color oro / Gold color leaf
RAL 9003

LD1650BFA

Foglia color argento / Silver color leaf
RAL 9003

LD1650RFR

Foglia color rame / Copper color leaf
RAL 9003

LD1650DFO

Nero - Foglia color oro craquelé / Black - Gold color leaf craquelé
RAL 9004

* Le lampade con finitura foglia color oro, foglia color argento, foglia color rame e con finitura craquelé non sono adatte per uso esterno.

* The lamps with gold color leaf, silver color leaf and copper color leaf finish and the lamps with craquelé finish are not suitable for outdoor use.

Pina

Supporto da terra

Floor stand



Video Pina



Supporto che trasforma la lampada da tavolo Pina in lampada con picchetto o lampada da terra. L'estremità inferiore del supporto si può montare secondo tre diverse configurazioni: solo con base; solo con picchetto; con picchetto e base, per aumentare la stabilità del supporto. La lampada Pina si alloggia esattamente nella parte superiore del supporto, senza agganciarsi, e può essere agilmente rimossa. Questo supporto non assolve la funzione di ricarica.

A floor stand that turns Pina into a floor lamp or a lamp with peg. The lower end of the stand can be mounted in three different configurations: with the base only, with the peg only, with both peg and base, to increase the stability of the stand. Pina lamp fits exactly in the upper part of the stand, without hooking for easy removal. The floor stand does not charge the lamp.



Pina table lamp sand + Pina floor stand sand
→ LD1650S3 + LD0651S3

Dati tecnici

Technical data

Corpo in alluminio verniciato
Painted aluminum body

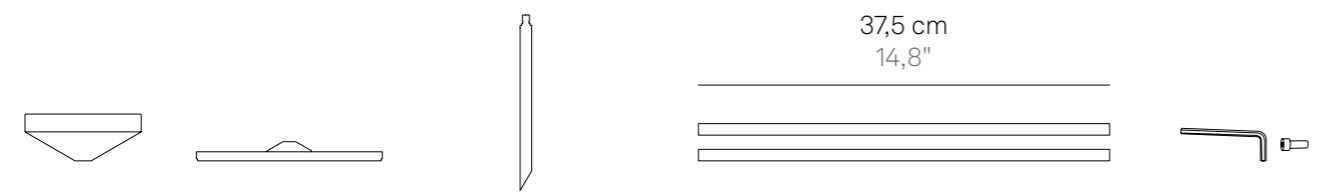
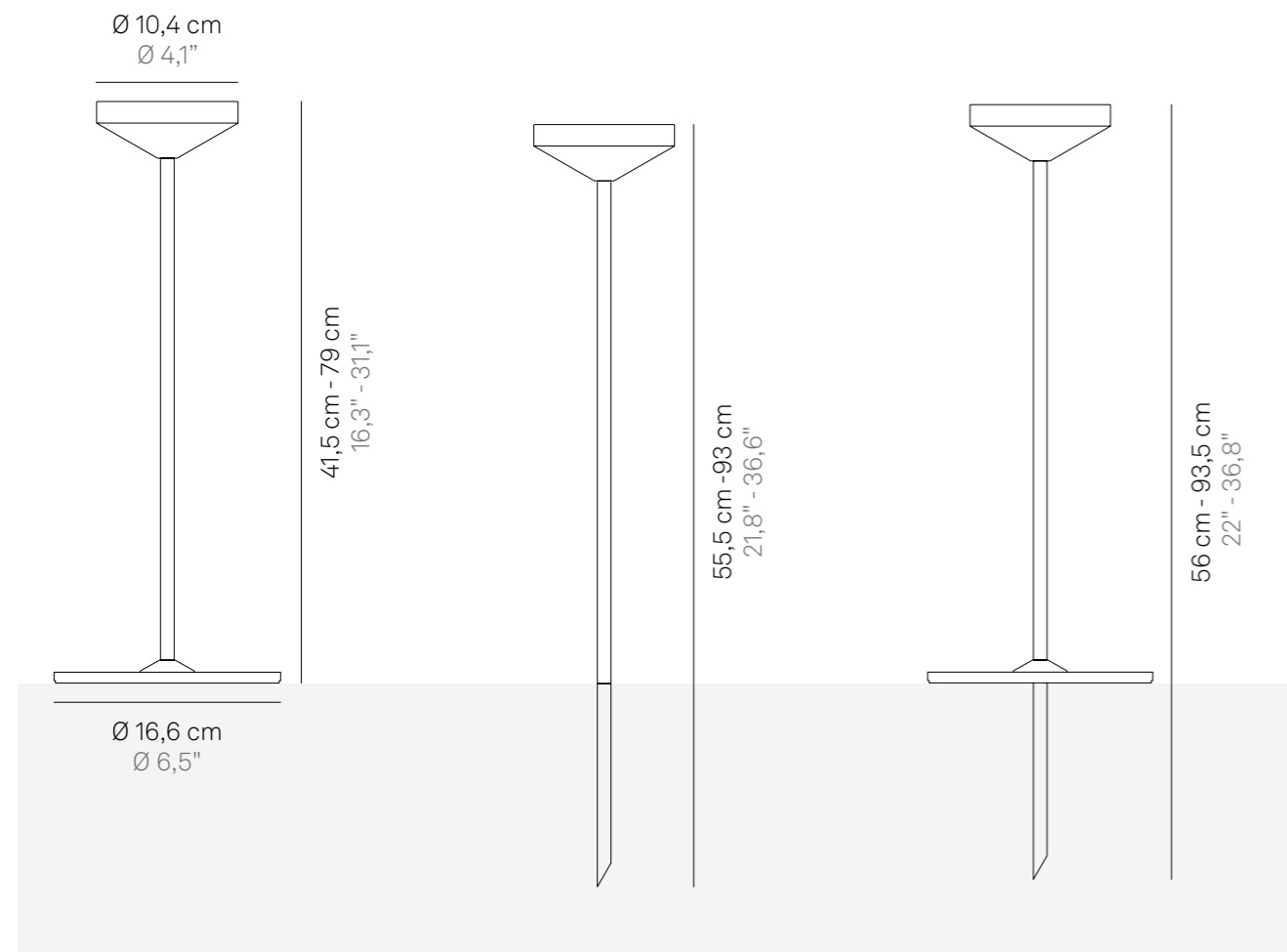

Componenti inclusi

Components included

Base d'appoggio per lampada
Housing for lamp

Base
Base

Picchetto
Peg

Stelo (2 pz.)
Stem (2 pcs.)

Kit di assemblaggio
Assembling kit



Pina table lamp white + Floor stand white
→ **LD1650B3** + **LD0651B3**

Finiture

Finishes



LD0651B3
Bianco
/ White
RAL 9003



LD0651R3
Corten



LD0651N3
Grigio scuro
/ Dark grey



LD0651D3
Nero
/ Black
RAL 9004



LD0651S3
Sabbia
/ Sand

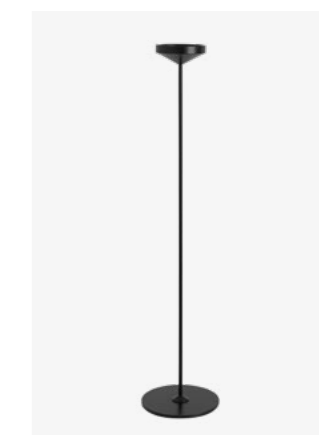

Pina

Vassoio in ceramica made in Italy

Ceramic tray made in Italy

NEW



Dati tecnici

Technical data

CE

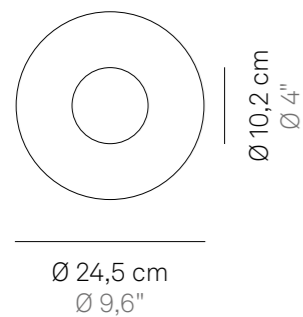

Vassoio in ceramica nella cui parte centrale concava, appositamente sagomata, si può alloggiare la lampada da tavolo Pina.

La stretta collaborazione con un'antica fabbrica di Civita Castellana - borgo viterbese dove l'arte della ceramica è attestata fin dal X secolo a.C. – consente a Zafferano di avvalersi di una produzione esclusiva di manufatti “Made in Italy”, decorati a mano su disegno proprio.

Ceramic tray with a concave center that houses the base of Pina.

The close partnership with a historic factory in Civita Castellana - a village near Rome, where the art of ceramics has been practiced since the 10th century BC - allows Zafferano to rely on the exclusive production of made in Italy artifacts, which are hand-painted according to Zafferano design.

Finiture

Finishes



LD065201
Bianco - Nero
White - Black



LD065202
Blu notte - blu
Navy blue - blue



LD065203
Sabbia - Azzurro
Sand - Light blue





Pina table lamp corten +
Ceramic tray sand - light blue
→ **LD1650R3 + LD065203**

Swap

Design Studio Kairos and Federico de Majo

Libellula ti muovi
 Quasi invisibile
 Diventi lucciola
 Ci accudisci con una piccola luce
 Vibrante di vetri e di raffinati veli
 Trasformi per noi la tua essenza
 E resti unica dolce compagna.

Dragonfly you move
 Almost invisible
 And become a firefly
 Watching over us with a small light
 Shimmering with glass and refined veils
 You transform your essence for us
 And remain the only sweet companion.

TAVOLO / ACCESSORI / MINI TAVOLO / ACCESSORI
 TABLE LAMP/ ACCESSORIES / MINI TABLE LAMP / ACCESSORIES



Swap table lamp white → **LD1030B3**
 Swap mini table lamp white → **LD1011B3**
 Cansiglio forest
 Treviso, Italy

Swap

Tavolo pro

Table lamp pro



Rispetto alla precedente, la nuova versione di Swap permette anche la regolazione dell'intensità luminosa (dimmerazione a 4 step) e la selezione della temperatura di colore della luce tra 2200 K, 2700 K e 3000 K. La nuova Swap inoltre ha altezza ridotta (29 cm). Swap è una lampada da tavolo a batteria, portatile e ricaricabile. Grazie a un alto indice di protezione, la lampada è utilizzabile anche all'esterno. Possiede un sistema di controllo elettronico che monitora e segnala l'autonomia residua della batteria, permettendo di ottimizzare le ricariche ed effettuarle sempre in maniera corretta. Swap è personalizzabile con paralumi in vetro, ceramica o tessuto, acquistabili separatamente. È dotata di base di ricarica a contatto; caricabatterie non incluso.

Compared to the previous one, the new version of Swap allows also dimming (4-step: 100%, 60%, 30%, 6%) and selecting the color temperature of the light to 2200 K, 2700 K or 3000 K. The new Swap is also smaller (29 cm / 11,4 in). Swap is a rechargeable battery-powered cordless table lamp. It is suitable for both indoor and outdoor use. An electronic control system monitors the remaining autonomy and ensures a constant luminous flux until the battery runs out. Recharging is therefore optimized and always properly done. Swap can be customized with glass, ceramic, or fabric lampshades, to be purchased separately. The lamp comes with a contact charging base; battery charger not included.



Swap table lamp black + fabric lampshade black
→ LD1030N3 + LD102005

Dati tecnici

Technical data

LED TOUCH DIMMER

2200-2700-3000 K | CRI>90
141-168-192 lm | 2 W | IP65
5 Vdc max 2A



Corpo in pressofusione di alluminio verniciato
Painted die-cast aluminum body

Schermo diffusore in policarbonato satinato
Satin polycarbonate diffuser

Adatta all'uso esterno (lampada IP65) e interno
(lampada su base di ricarica IP20)
Suitable for outdoor (lamp IP65) and indoor use
(lamp on charging base IP20)

Durata di circa 13 h alla massima potenza
Battery lasts about 13 h at full power

Tempo di ricarica a 2A: 3 h
Charging time at 2A: 3 h

Pacco batteria al litio ricaricabile e sostituibile
Rechargeable and replaceable lithium battery pack

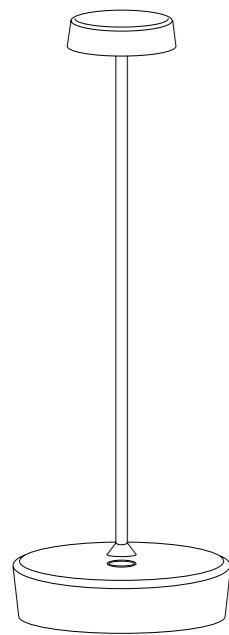

Ø 10 x 29 cm
Ø 3,9 x 11,4 in

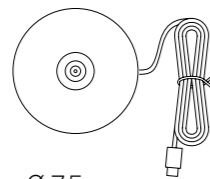

Ø 7,5 cm
Ø 2,9 in

Finiture

Finishes

**LD1030B3**

Bianco / White
RAL 9002

**LD1030R3**

Corten

**LD1030N3**

Nero / Black
RAL 9005

Componenti inclusi

Components included

Base di ricarica a contatto
Contact charging base

Accessori non inclusi

Accessories not included

Caricatore / Charger
100-240 V | USB Type A
LD0300UC

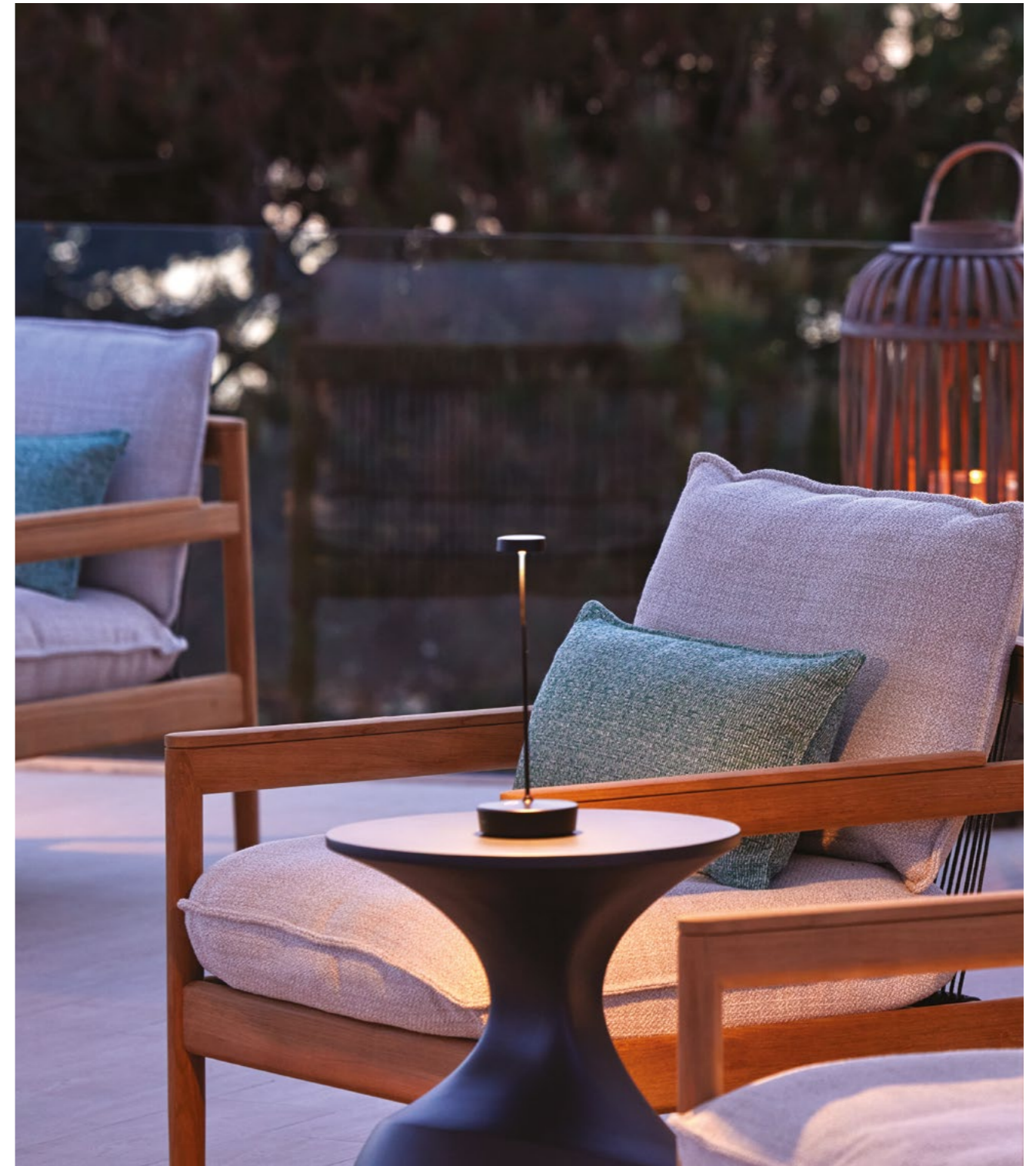

Swap table lamp black → **LD1030N3**
Resort IKOS Andalusia
Marbella-Estepona, Spain
Photo Ikos Resorts

Swap

Paralume in tessuto

Fabric lampshade



Finiture

Finishes



LD102000
Bianco / White



LD102005
Nero / Black

Dati tecnici

Technical data

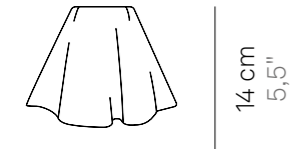

Ø 15 cm
Ø 5,9"

14 cm
5,5"

Componenti inclusi
Components included

Magnete e dima
Magnet and cut-out

Video tutorial: montaggio paralume
Tutorial video: installation of the lampshade



Paralume morbido in tessuto elastico ignifugo, lavabile e ingualcibile, con dischetto in policarbonato e orlo sopraffilato, che si fissa alla testa di Swap tramite un magnete.

A soft lampshade made of fire-retardant elastic fabric, which is washable and crease-resistant, with a polycarbonate disc and a zig-zag edging, that is fixed to the head of the lamp with a magnet.



Swap

Paralume in vetro

Glass lampshade



Dati tecnici

Technical data

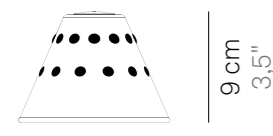

Ø 13 cm
Ø 5,1"

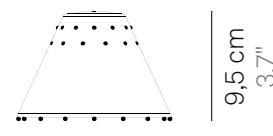

Ø 13 cm
Ø 5,1"

Componenti inclusi

Components included

Magnete e dima
Magnet and cut-out

Video tutorial: montaggio paralume
Tutorial video: installation of the lampshade



Paralume in vetro borosilicato soffiato e lavorato a mano con decorazioni a rilievo, che si fissa alla testa di Swap tramite un magnete.

A handcrafted, blown borosilicate glass lampshade, with relief decorations, that is fixed to the head of the lamp with a magnet.

Finiture

Finishes



LD102001
Bianco / White



LD102002
Nero / Black



LD102003
Ambra / Amber



LD102004
Blu / Blue



LD102011
Bianco / White



LD102012
Nero / Black



LD102013
Ambra / Amber



LD102014
Blu / Blue



Swap

Paralume in ceramica made in Italy

Ceramic lampshade
made in Italy

NEW



Dati tecnici

Technical data

CE

Ø 5,7 cm
Ø 2,2"

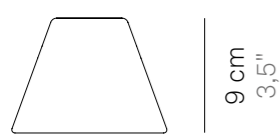

Ø 12,2 cm
Ø 4,8"

9 cm
3,5"

Componenti inclusi
Components included

Magnete e dima
Magnet and cut-out

Video tutorial: montaggio paralume
Tutorial video: installation of the lampshade



Paralume in ceramica che si fissa alla testa di Swap tramite un magnete.

La stretta collaborazione con un'antica fabbrica di Civita Castellana - borgo viterbese dove l'arte della ceramica è attestata fin dal X secolo a.C. - consente a Zafferano di avvalersi di una produzione esclusiva di manufatti "Made in Italy", decorati a mano su disegno proprio o del cliente.

Ceramic lampshade that is fixed to the head of the lamp with a magnet.

The close partnership with a historic factory in Civita Castellana - a village near Rome, where the art of ceramics has been practiced since the 10th century BC - allows Zafferano to rely on the exclusive production of made in Italy artifacts, which are hand-painted according to Zafferano design; customization available.

Finiture

Finishes



LD102101
Bianco - Nero
/ White - Black



LD102103
Sabbia - Azzurro
/ Sand - Light blue



Swap mini

Tavolo pro

Table lamp pro



Swap mini è una lampada da tavolo a batteria, portatile e ricaricabile. Sulla base è presente un controllo "touch", che permette l'accensione e la regolazione dell'intensità luminosa. Grazie a un alto indice di protezione, la lampada è utilizzabile anche all'esterno (ad eccezione dei modelli con finitura galvanica, delle quali è sconsigliato l'uso continuativo in esterni). Possiede un sistema di controllo elettronico che monitora e segnala l'autonomia residua della batteria, permettendo di ottimizzare le ricariche ed effettuarle sempre in maniera corretta. È dotata di base di ricarica a contatto; caricabatterie non incluso. È possibile personalizzare la lampada con paralumi in ceramica, acquistabili separatamente

Swap mini is a rechargeable battery-powered cordless table lamp. A "touch" control on the base allows switching on/off and dimming. It is suitable for both indoor and outdoor use (except gold and silver finishes). An electronic control system monitors the remaining autonomy and ensures a constant luminous flux until the battery runs out. Recharging is therefore optimized and always properly done. The lamp comes with a contact charging base; the battery charger is not included. Swap mini can be customized choosing from a range of ceramic lampshades, to be purchased separately



Swap mini table lamp white
→ LD1011B3



Swap mini table lamp
Capri blue → **LD1011K3**



Swap mini table lamp corten
+ ceramic lampshade sand-light blue
→ **LD1011R3 + LD101103**

Dati tecnici

Technical data

LED TOUCH DIMMER | 2700K | CRI>90 |
2W | 267lm | **IP65** | 5 Vdc max 1A



Corpo in pressofusione di alluminio verniciato
Painted die-cast aluminum body

Schermo diffusore in policarbonato
Polycarbonate diffuser

Adatta all'uso esterno (lampada IP65) e interno
(lampada su base di ricarica IP20)

Suitable for outdoor (lamp IP65) and indoor use
(lamp on charging base IP20)

Durata di circa 13 h alla massima potenza
Battery lasts about 13 h at full power

Tempo di ricarica a 1A: 6 h
Charging time at 1A: 6 h

Pacco batteria al litio ricaricabile e sostituibile
Rechargeable and replaceable lithium battery pack

Avvertenze

Remarks

Le lampade con finitura galvanica lucida oro e cromo
non sono adatte per uso esterno.

The lamps with gold and chrome glossy galvanic finish
are not suitable for outdoor use.

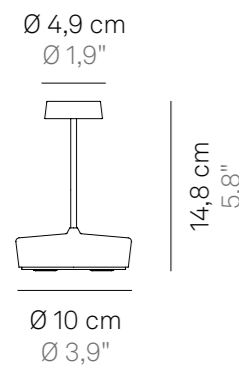

Ø 7,5 cm
Ø 2,9"

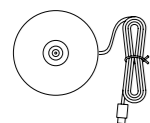
**Componenti inclusi**

Components included

Base di ricarica a contatto
Contact charging base

Accessori non inclusi

Accessories not included

Caricabatterie
Charger

Finiture

Finishes



LD1011B3
Bianco / White
RAL 9002



LD1011R3
Corten



LD1011N3
Nero / Black
RAL 9005



LD1011O3 *
Oro lucido
/ Glossy gold



LD1011C3 *
Cromo lucido
/ Glossy chrome



LD1011K3
Blu Capri
/ Capri blue
RAL 5019



LD1011L3
Lilla / Lilac
RAL 4005



LD1011V3
Verde mela
/ Apple green
RAL 6018



LD1011Z3
Arancio / Orange
RAL 2008

* Le lampade con finitura galvanica lucida oro e cromo non sono adatte per uso esterno.

* The lamps with gold and chrome glossy galvanic finish are not suitable for outdoor use.

Swap mini

Paralume in ceramica made in Italy

Ceramic lampshade
made in Italy



NEW

Dati tecnici

Technical data

CE

Ø 5,7 cm
Ø 2,2"

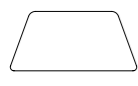

4 cm
1,6"

Ø 8,5 cm
Ø 3,3"

Componenti inclusi Components included

Magnete e dima
Magnet and cut-out

Video tutorial: montaggio paralume
Tutorial video: installation of the lampshade



Paralume in ceramica che si fissa alla testa di Swap mini tramite un magnete. La stretta collaborazione con un'antica fabbrica di Civita Castellana - borgo viterbese dove l'arte della ceramica è attestata fin dal X secolo a.C. - consente a Zafferano di avvalersi di una produzione esclusiva di manufatti "Made in Italy", decorati a mano su disegno proprio o del cliente.

Ceramic lampshade that is fixed to the head of the lamp with a magnet. The close partnership with a historic factory in Civita Castellana - a village near Rome, where the art of ceramics has been practiced since the 10th century BC - allows Zafferano to rely on the exclusive production of made in Italy artifacts, which are hand-painted according to Zafferano design; customization available.

Finiture Finishes



LD101101
Bianco - Nero
/ White - Black



LD101102
Blu notte - Blu
/ Navy blue - Blue



LD101103
Sabbia - Azzurro
/ Sand - Light blue



LD101104
Pesci azzurri
/ Light blue fish



LD101105
Pois verdi
/ Green dots



LD101106
Pois arancio
/ Orange dots



LD101107
Pois azzurri
/ Light blue dots



LD101108
Pois rosso
/ Red dots



LD101109
Pois neri
/ Black dots

Push-up

Cuore di luce
Animo forte
Ti apri come madreperla
Donando un immediato piacere
Una inaspettata luminosità.

Heart of light
Powerful spirit
You open like a mother-of-pearl shell
Giving instant pleasure,
Unexpected luminosity.

TAVOLO
TABLE LAMP



Push-up table lamp corten → **LD1050R3**
Padua, Italy

Push-up

Tavolo pro Table lamp pro

NEW



Video Push-up

Push-up è una lampada da tavolo a batteria, portatile e ricaricabile. Premendo la parte superiore della lampada, questa si solleva e contemporaneamente si accende; premendo nuovamente fino alla chiusura, la lampada si spegne. Sotto la base è presente un controllo "touch", che – quando la parte superiore della lampada è sollevata – permette lo spegnimento, la regolazione dell'intensità luminosa e la selezione della temperatura di colore della luce tra 2200K, 2700K e 3000K. Grazie a un alto indice di protezione, la lampada è utilizzabile anche all'esterno. Possiede un sistema di controllo elettronico che monitora e segnala l'autonomia residua della batteria, permettendo di ottimizzare le ricariche ed effettuarle sempre in maniera corretta. È dotata di base di ricarica a contatto; caricabatterie non incluso.

Push-up is a rechargeable battery-powered cordless table lamp. Pushing the lid down, lifts the diffuser up and turns the light on; pushing the lid back down, closes the lamp while turning the light off. A "touch" control hidden under the base allows switching on/off, dimming, and selecting the color temperature of the light (2200K, 2700K or 3000K). It is suitable for both indoor and outdoor use. An electronic control system monitors the remaining autonomy and ensures a constant luminous flux until the battery runs out. Recharging is therefore optimized and always properly done. The lamp comes with a contact charging base; the battery charger is not included.



Push-up table lamp
white → LD1050B3

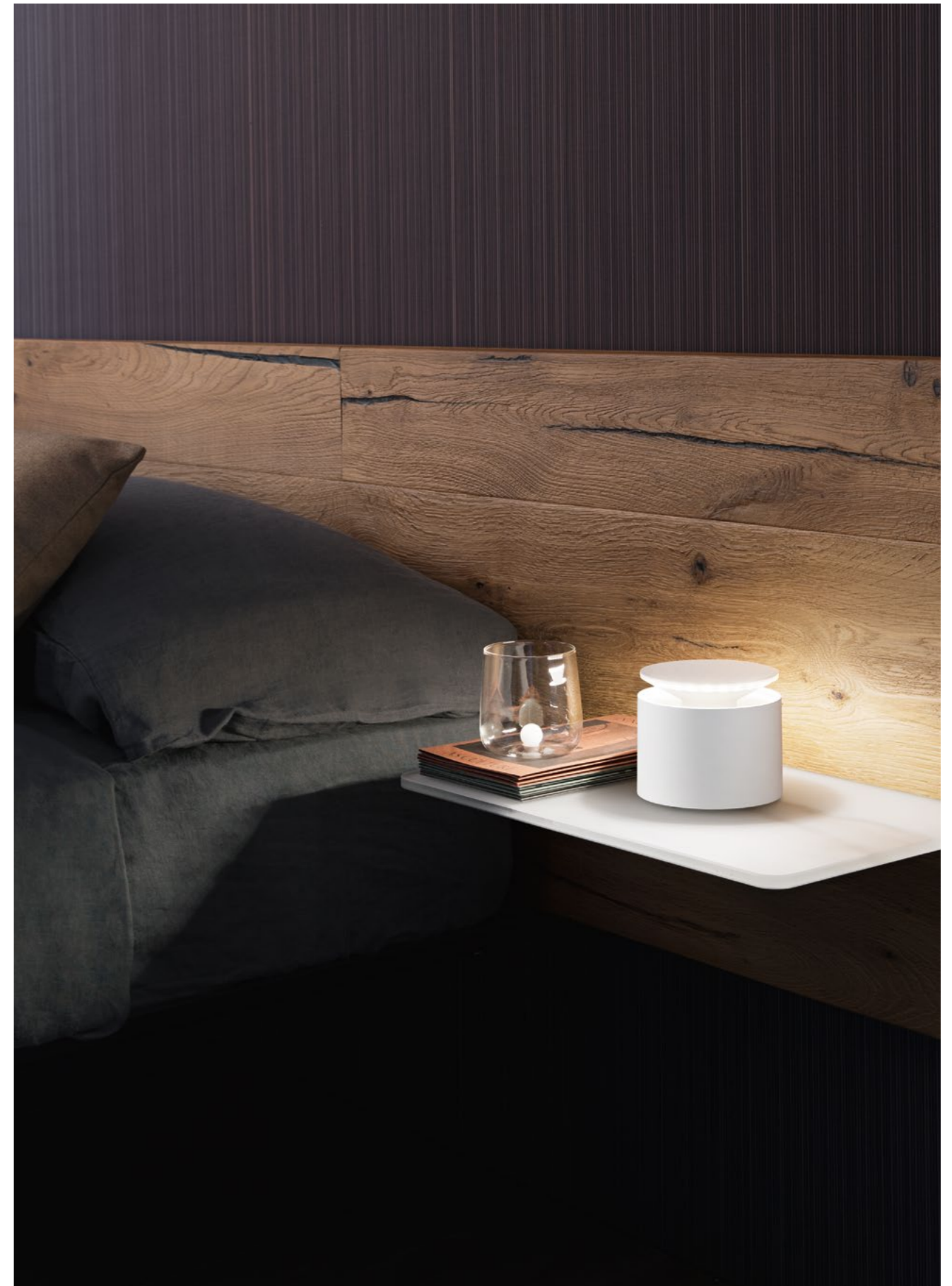

Dati tecnici

Technical data

LED TOUCH DIMMER | 2200-2700-3000K | CRI>80 | 2,2W | 207-235-248lm | **IP54** | 5 Vdc max 1A

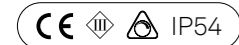

Corpo in pressofusione di alluminio verniciato
Painted die-cast aluminum body

Schermo diffusore in policarbonato
Polycarbonate diffuser

Adatta all'uso esterno (lampada IP54) e interno (lampada su base di ricarica IP20)

Suitable for outdoor (lamp IP54) and indoor use (lamp on charging base IP20)

Durata di circa 11/12 h alla massima potenza
Battery lasts about 11/12 h at full power

Tempo di ricarica a 1A: 5/6 h
Charging time at 1A: 5/6 h

Pacco batteria al litio ricaricabile e sostituibile
Rechargeable and replaceable lithium battery pack

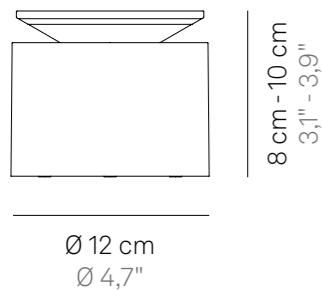

Ø 12 cm
Ø 4,7"

Ø 10 cm
Ø 3,9"

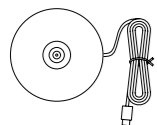
**Componenti inclusi**

Components included

Base di ricarica a contatto
Contact charging base

Accessori non inclusi

Accessories not included

Caricabatterie
Charger

Finiture

Finishes



LD1050B3
Bianco / White
RAL 9003



LD1050R3
Corten



LD1050N3
Grigio scuro / Dark grey



LD1050S3
Sabbia / Sand



Push-up table lamp dark grey → **LD1050N3**
Push-up table lamp corten → **LD1050R3**

Home

Voglio una casa illuminata
 Tanto grande e tanto piccola
 Come la penso ogni giorno
 Con tanti o pochi amici
 Vere presenze
 Penso la casa sul mare e sulla sabbia
 Sul prato ombreggiato dal tiglio
 E sulla montagna dopo il tramonto
 Che racconta dei nostri tanti passi.

I'd like a bright house
 As large and as small
 As I imagine it every day
 With many or a few friends
 True presences
 I imagine a house by the sea and on the sand
 On the lawn, in the shade of a linden tree
 And in the mountains after sunset
 That reveals our many steps.

TAVOLO / SUPPORTO PARETE / PALETTO (SOLAR)
 TABLE LAMP / WALL LAMP KIT / BOLLARD (SOLAR LAMP)



Home table lamp white → **LD0258B3**
 Home table lamp dark grey → **LD0258N3**

Euganean hills
 Padua, Italy

Home

Tavolo pro Table lamp pro



Home è una lampada da tavolo a batteria, portatile e ricaricabile. Sulla base è presente un controllo "touch", che permette l'accensione e la regolazione dell'intensità luminosa. Grazie a un alto indice di protezione, la lampada è utilizzabile anche all'esterno. Possiede un sistema di controllo elettronico che monitora e segnala l'autonomia residua della batteria, permettendo di ottimizzare le ricariche ed effettuarle sempre in maniera corretta. È dotata di base di ricarica a contatto; caricabatterie incluso. Home può diventare una lampada da parete tramite l'apposito accessorio, acquistabile separatamente.

Home is a rechargeable battery-powered cordless table lamp. A "touch" control on the base allows switching on/off and dimming. It is suitable for both indoor and outdoor use. An electronic control system monitors the remaining autonomy and ensures a constant luminous flux until the battery runs out. Recharging is therefore optimized and always properly done. The lamp comes with a contact charging base; the battery charger is included. Home can become a wall lamp thanks its dedicated accessory, to be purchased separately.

Home table lamp white
→ **LD0258B3**



Dati tecnici

Technical data

LED TOUCH DIMMER | 100-240V |
3000K | CRI>80 | 50-60Hz | 2,2W |
260lm | **IP54** | 5Vdc max 1A

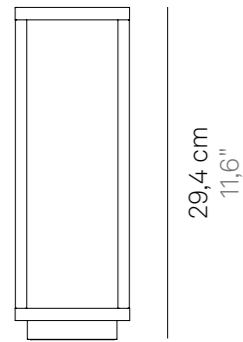

10 x 10 cm
3,9" x 3,9"

Ø 7,5 cm
Ø 2,9"

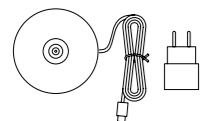

Corpo in pressofusione di alluminio verniciato
Painted die-cast aluminum body

Schermo diffusore in policarbonato
Polycarbonate diffuser

Adatta all'uso esterno (lampada IP54) e interno
(lampada su base di ricarica IP20)

Suitable for outdoor (lamp IP54) and indoor use
(lamp on charging base IP20)

Durata di circa 12 h alla massima potenza
Battery lasts about 12 h at full power

Tempo di ricarica a 1A: 6/8 h
Charging time at 1A: 6/8 h

Pacco batteria al litio ricaricabile e sostituibile
Rechargeable and replaceable lithium battery pack

Finiture

Finishes



LD0258B3
Bianco / White
RAL 9003



LD0258R3
Corten



LD0258N3
Grigio scuro / Dark grey

Componenti inclusi

Components included

Base di ricarica a contatto
Contact charging base

Caricabatterie
Charger

Home

Supporto parete Wall lamp kit

NEW



Dati tecnici Technical data

CE

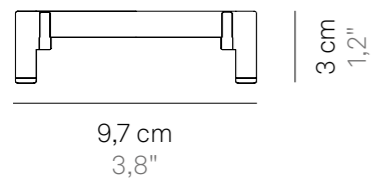

Finiture Finishes



LD0259B3
Bianco
/ White
RAL 9003



LD0259R3
Corten



LD0259N3
Grigio scuro
/ Dark grey

Supporto in pressofusione d'alluminio verniciato
Painted die-cast aluminum element



Supporto che trasforma la lampada da tavolo Home in lampada da parete. La lampada può essere usata nel suo supporto fisso, ma anche rimossa e portata con sé da un ambiente all'altro.

A wall bracket that turns Home into a wall lamp. The lamp can be used in its fixed housing or detached and carried from one place to another.

Home table lamp white
+ Home wall lamp kit white
→ **LD0258B3** + **LD0259B3**

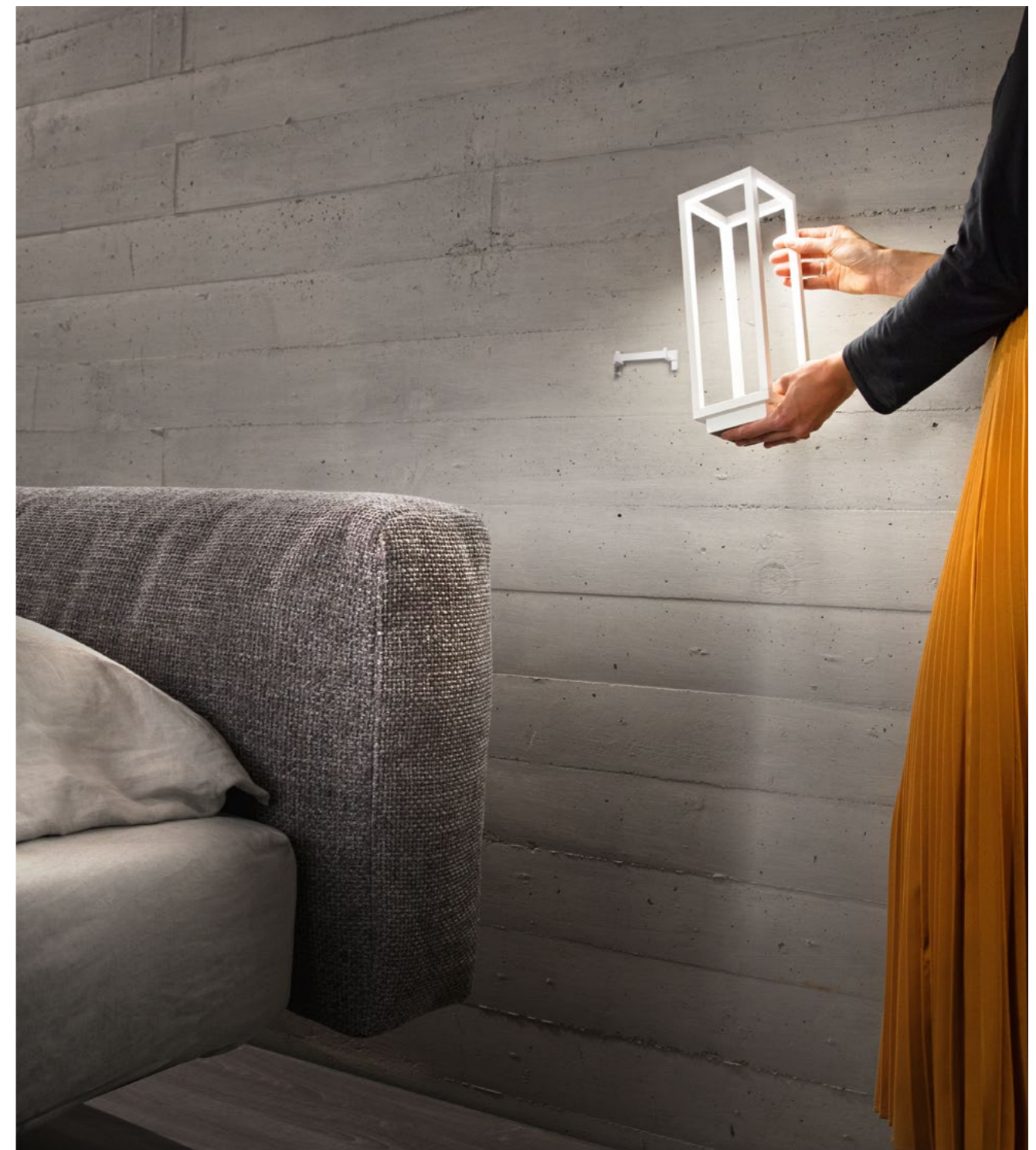

Home Solar

Paletto Bollard



Paletto adatto all'uso esterno, disponibile in due modelli: basso, alto. Ha struttura in pressofusione di alluminio verniciato grigio scuro o corten e diffusore in polycarbonato trasparente. Home Solar è privo di collegamento alla rete elettrica e dotato di pannello solare, sensore crepuscolare, sensore di movimento e picchetto per installazione diretta su terreno. I sensori della lampada sono comandati da due interruttori: quando il sensore crepuscolare è attivo (☾) e rileva una luminosità ambientale minore di 150 Lux, la lampada si accende al 50% della sua intensità; quando anche il sensore di movimento è attivo (👤) e rileva un movimento, la lampada si accende al massimo della sua potenza per poi abbassarla al 10%.

Bollard lamp for outdoor use, available in two models: low and high. It has a dark grey or corten painted die-cast aluminum frame and a transparent polycarbonate diffuser. Home Solar is mains-independent and fitted with a solar panel, dusk sensor, motion sensor and peg for inserting it directly into the ground. The lamp sensors are controlled by two switches: when the dusk sensor is active (☾) and detects an ambient brightness of less than 150 Lux, the lamp switches on at 50% of its intensity. When the motion sensor is active (👤), too, and detects movement, the lamp switches on at full power, and then lower its intensity to 10%.



Home Solar bollard
dark gray → LD0257G3

Dati tecnici

Technical data

LED
3000 K | 3,7 V | CRI>84
415 lm | 2,2 W | IP54



Corpo in pressofusione di alluminio verniciato
Die-cast painted aluminum body
Schermo diffusore in policarbonato
Polycarbonate diffuser
Lampada dotata di sensore crepuscolare
e di movimento
Lamp fitted with dusk and motion sensors
Ricarica: 6-8 h (luce solare)
Charge: 6-8 h (sunshine)
Durata batteria: luce piena 10-11h; micro 20 - 25h
Work time: Full power 10-11h; energy saving 20 - 25h

Componenti inclusi

Components included

Viti per cemento e picchetto in metallo
Screws and metal peg

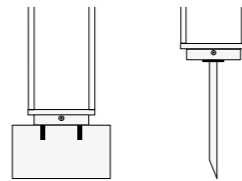

Accessori non inclusi

Accessories not included

Base zavorrata / Stabilizing base
Accessorio per stabilizzare la lampada
senza ancorarla al terreno.
Accessory to stabilise the lamp without
anchoring it to the ground.



16 x 16 x 0,8 cm
6,3 x 6,3 x 0,3 in



LD0255R3
Corten



LD0255G3
Grigio scuro
Dark gray

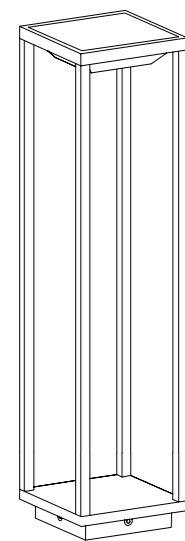

14 x 14 x 50 cm
5,5 x 5,5 x 19,7 in

Finiture

Finishes



LD0256R3
Corten



LD0256G3
Grigio scuro
/ Dark gray

Dati tecnici

Technical data

LED
3000 K | 3,7 V | CRI>84
415 lm | 2,2 W | IP54



Corpo in pressofusione di alluminio verniciato
Die-cast painted aluminum body
Schermo diffusore in policarbonato
Polycarbonate diffuser
Lampada dotata di sensore crepuscolare
e di movimento
Lamp fitted with dusk and motion sensors
Ricarica: 6-8 h (luce solare)
Charge: 6-8 h (sunshine)
Durata batteria: luce piena 10-11h; micro 20 - 25h
Work time: Full power 10-11h; energy saving 20 - 25h

Componenti inclusi

Components included

Viti per cemento e picchetto in metallo
Screws and metal peg

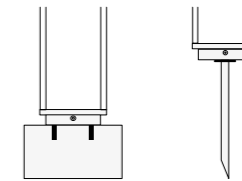

Accessori non inclusi

Accessories not included

Base zavorrata / Stabilizing base
Accessorio per stabilizzare la lampada
senza ancorarla al terreno.
Accessory to stabilise the lamp without
anchoring it to the ground.



16 x 16 x 0,8 cm
6,3 x 6,3 x 0,3 in



LD0255R3
Corten



LD0255G3
Grigio scuro
Dark gray

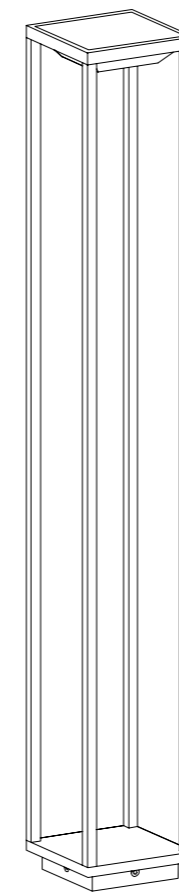

14 x 14 x 100 cm
5,5 x 5,5 x 39,4 in

Finiture

Finishes



LD0257R3
Corten



LD0257G3
Grigio scuro
/ Dark gray

Dama

A stone shines
light awakens it
while a small moon
radiates a faint yet vibrant glow.
The endless passage of much water
has patiently smoothed it.

Un sasso risplende
la luce lo risveglia
mentre una piccola luna
emana un chiarore flebile ma vivo.
È il passaggio perpetuo di tanta acqua
che paziente lo ha levigato.

TAVOLO
TABLE LAMP



Dama table lamp white
→ **LD0610B3**
Piave riverbed
Treviso, Italy

Dama

Tavolo pro Table lamp pro



Dama è una lampada da tavolo a batteria, portatile e ricaricabile. Nella parte superiore della testa è presente un controllo "touch", che permette l'accensione, la regolazione dell'intensità luminosa e la selezione della temperatura di colore della luce tra 2200K, 2700K e 3000K. Grazie a un alto indice di protezione, la lampada è utilizzabile anche all'esterno. Possiede un sistema di controllo elettronico che monitora e segnala l'autonomia residua della batteria, permettendo di ottimizzare le ricariche ed effettuarle sempre in maniera corretta. È dotata di base di ricarica a contatto; caricabatterie incluso.

Dama is a rechargeable battery-powered cordless table lamp. A "touch" control on the head allows switching on/off, dimming, and selecting the color temperature of the light (2200K, 2700K or 3000K). It is suitable for both indoor and outdoor use. An electronic control system monitors the remaining autonomy and ensures a constant luminous flux until the battery runs out. Recharging is therefore optimized and always properly done. The lamp comes with a contact charging base; the battery charger is included.

Dama table lamp white
→ **LD0610B3**



Dati tecnici

Technical data

LED TOUCH DIMMER | 100-240V | 2200-2700-3000K | CRI>80 | 50-60Hz | 2,2W | 194-219-221lm | **IP54** | 5Vdc max 1A

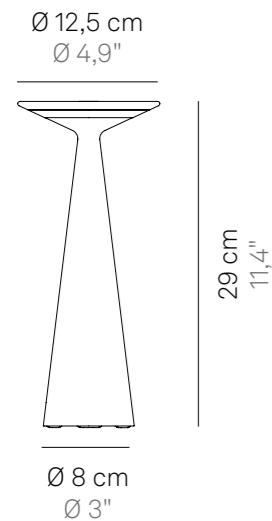

Ø 7,5 cm
Ø 2,9"

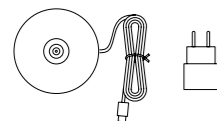

Corpo in pressofusione di alluminio verniciato
Painted die-cast aluminum body

Schermo diffusore in policarbonato
Polycarbonate diffuser

Adatta all'uso esterno (lampada IP54) e interno (lampada su base di ricarica IP20)

Suitable for outdoor (lamp IP54) and indoor use (lamp on charging base IP20)

Durata di circa 9 h alla massima potenza
Battery lasts about 9 h at full power

Tempo di ricarica a 1A: 6 h
Charging time at 1A: 6 h

Pacco batteria al litio ricaricabile e sostituibile
Rechargeable and replaceable lithium battery pack

Componenti inclusi

Components included

Base di ricarica a contatto
Contact charging base

Caricabatterie
Charger

Finiture

Finishes



LD0610B3
Bianco / White
RAL 9003

LD0610N3
Nero opaco / Black
RAL 9004



Dama table lamp white
→ **LD0610B3**
Ristorante Le Lampare
al Fortino - Trani, Italy
Photo Vito Rizzi Photographer

Olimpia

Design Federico de Majo

Luna luminosa, piena
la tua luce
penetra nei solchi, negli anfratti.
Gradino dopo gradino
ci avviciniamo.

Bright full moon
your light
penetrates furrows and crevices.
Step by step
we draw near.

TAVOLO
TABLE LAMP

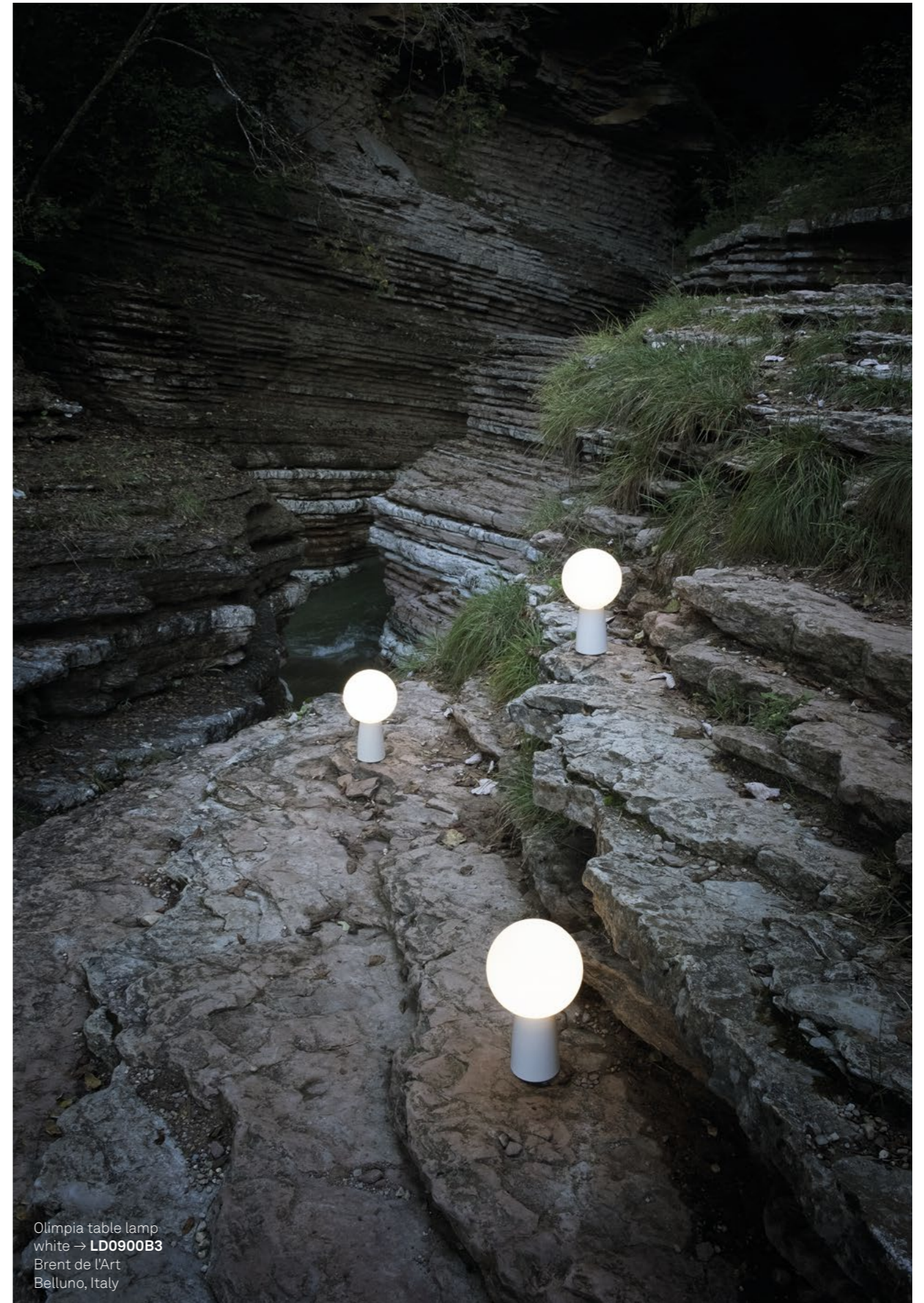

Olimpia table lamp
white → **LD0900B3**
Brent de l'Art
Belluno, Italy

Olimpia

Tavolo pro Table lamp pro



Olimpia è una lampada da tavolo a batteria, portatile e ricaricabile. Sulla base è presente un controllo "touch", che permette l'accensione e la regolazione dell'intensità luminosa. Grazie a un alto indice di protezione, la lampada è utilizzabile anche all'esterno (ad eccezione dei modelli con finitura galvanica, delle quali è sconsigliato l'uso continuativo in esterni). È possibile rendere più caldo il colore della luce, sostituendo il filtro già presente sulla sorgente luminosa con quello color ambra (fornito in dotazione). È dotata di base di ricarica a contatto; caricabatterie incluso.

Olimpia is a rechargeable battery-powered cordless table lamp. A "touch" control on the base allows switching on/off and dimming. It is suitable for both indoor and outdoor use (except gold and silver finishes). The color temperature of the light can be changed to warmer by swapping the filter onboard with the amber one (included). The lamp comes with a contact charging base; the battery charger is included.

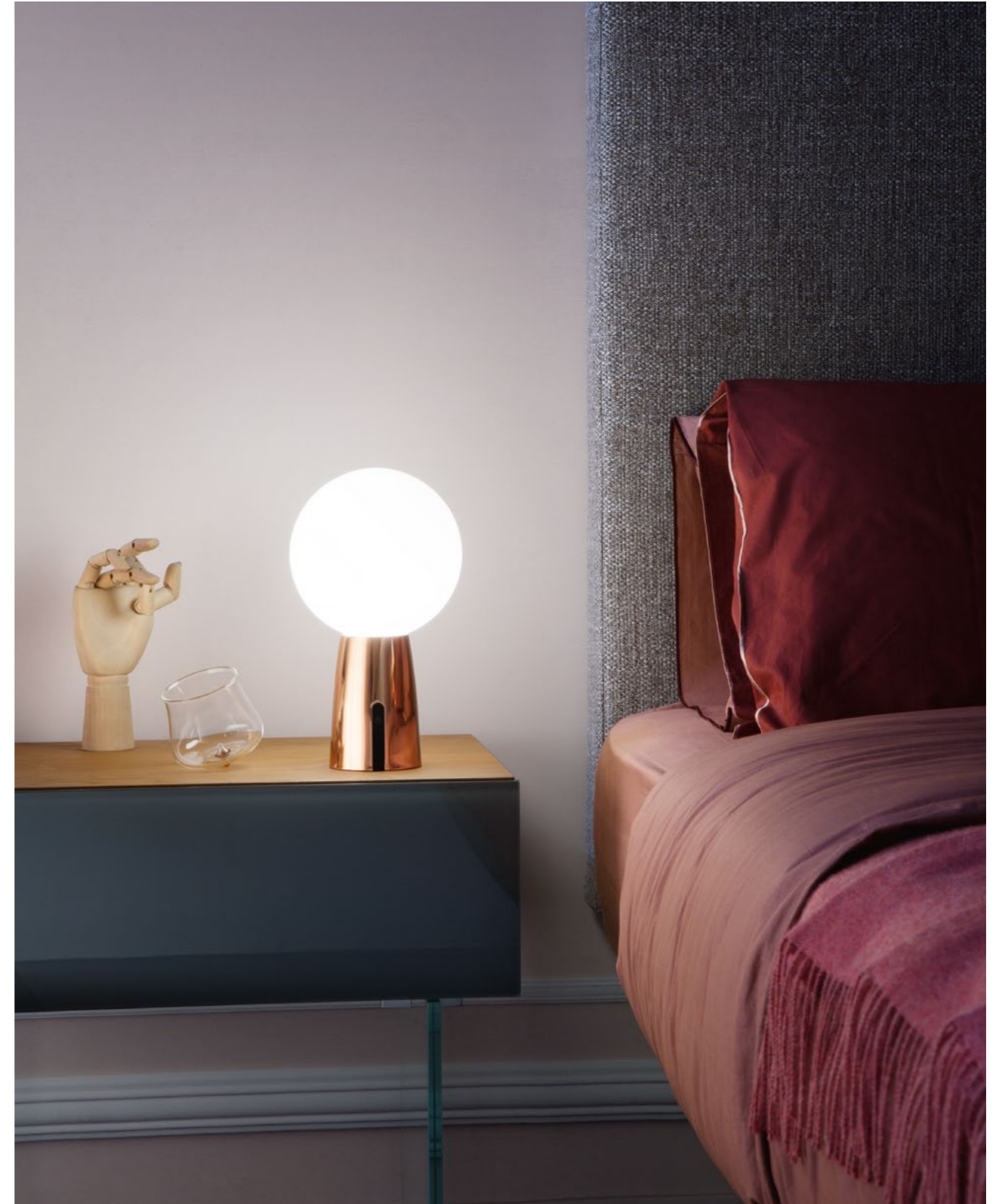

Olimpia table lamp copper
→ LD0900E3

Dati tecnici

Technical data

LED TOUCH DIMMER | 100-240V |
3000K | CRI>80 | 50-60Hz | 2,5W |
268lm | **IP54** | 5Vdc max 1A



Corpo in pressofusione di alluminio verniciato
Painted die-cast aluminum body

Schermo diffusore in policarbonato
Polycarbonate diffuser

Adatta all'uso esterno (lampada IP54) e interno
(lampada su base di ricarica IP20)

Suitable for outdoor (lamp IP54) and indoor use
(lamp on charging base IP20)

Durata di circa 9 h alla massima potenza
Battery lasts about 9 h at full power

Tempo di ricarica a 1A: 9 h
Charging time at 1A: 9 h

Pacco batteria al litio ricaricabile e sostituibile
Rechargeable and replaceable lithium battery pack

Avvertenze

Remarks

Le lampade con finitura oro, cromo e rame
non sono adatte per uso esterno.
The lamps with gold, chrome and silver finish
are not suitable for outdoor use.

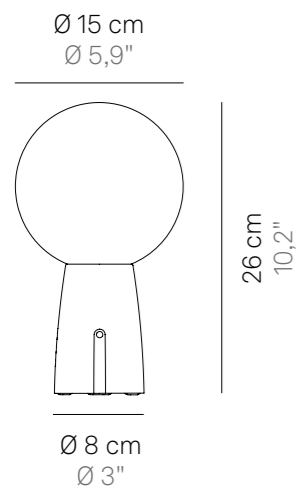

Ø 7,5 cm
Ø 2,9"

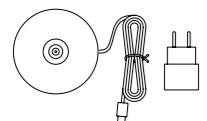

Ø 3,3 cm
Ø 1,3"

Componenti inclusi

Components included

Base di ricarica a contatto
Contact charging base

Caricabatterie
Charger

Filtro
Lens

Finiture

Finishes



LD0900B3
Bianco / White
RAL 9003



LD0900N3
Grigio scuro / Dark grey



LD090003 *
Oro lucido / Glossy gold



LD0900C3 *
Cromo lucido / Glossy
chrome



LD0900E3 *
Rame lucido
/Glossy copper

* Le lampade con finitura color oro, cromo e rame non sono adatte per uso esterno.
* The lamps with gold, chromo and copper finish are not suitable for outdoor use.

Sister Light

WI-FI

Design Federico de Majo

An enchanted forest
rich in greenery
and glowing mushrooms.
Eyes of elves, hidden
spy on your many powers.

Un bosco incantato
ricco di vegetazione
e funghi fosforescenti.
Occhi di elfi, nascosti
spiano le tue molteplici abilità.

TAVOLO WI-FI / MINI TAVOLO WI-FI / PICCHETTO WI-FI / PARETE WI-FI
WI-FI TABLE LAMP / WI-FI MINI TABLE LAMP / WI-FI LAMP WITH PEG / WI-FI WALL LAMP



Sister Light table lamp gold → **LD108003**
Sister Light mini table lamp gold → **LD108103**
Rosoline pine forest
Rovigo, Italy



Sister Light table lamp
copper → **LD1080R3**
42 Restaurant & Bar
Esztergom, Hungary
Photo Patrik Fábian



Sister Light

WI-FI

Design Federico de Majo



Video Sister
Light Wi-Fi ↗



Sister Light Wi-Fi è una nuova collezione di lampade a batteria, portatili e ricaricabili, controllabili anche da remoto mediante l'utilizzo dell'applicazione Zafferano Lighting. La collezione comprende le tipologie da tavolo (in due altezze), parete e con picchetto. Un controllo "touch" presente nella parte superiore della testa permette accensione, dimmerazione a 4 step e selezione della temperatura di colore della luce (2200 K, 2700 K, 3000 K e 4000 K). L'app permette molti controlli aggiuntivi (*). Grazie all'indice di protezione IP65, sono utilizzabili anche all'esterno; sono inoltre resistenti alla nebbia salina (1500 h). Possiedono un sistema di controllo elettronico che monitora l'autonomia residua e garantisce un flusso luminoso costante fino all'esaurimento della batteria, permettendo di ottimizzare le ricariche ed effettuarle sempre in maniera corretta. Tutti i modelli si ricaricano svitando la testa e ponendola sulla base di ricarica a contatto, inclusa; i modelli da tavolo si ricaricano anche appoggiando la lampada sulla base di ricarica a contatto. Caricabatterie non incluso.

Sister Light Wi-Fi is a new collection of portable, rechargeable battery-operated lamps that can be remote controlled using the Zafferano Lighting app. The collection includes the following models: table lamp (two heights), wall lamp and lamp with peg. On the head, a touch control allows you to turn it on/off, dim (4-step: 100%, 60%, 30%, 6%) and select the color temperature of the light among 2200 K, 2700 K, 3000 K and 4000 K. Many additional controls are available in app (*). With their IP65 rating, the lamps can also be used outdoors; they are salt spray resistant (1500 h). All models feature an electronic control system that monitors the remaining autonomy and ensures a constant luminous flux until the battery runs out. Recharging is therefore optimized and always properly done. All models can be recharged by unscrewing the top and positioning it on the contact charging base, included. The table versions can be recharged also by positioning the whole lamp on the contact charging base. Battery charger not included.



Sister Light Wi-Fi
table lamp pearly black → LD1080D3

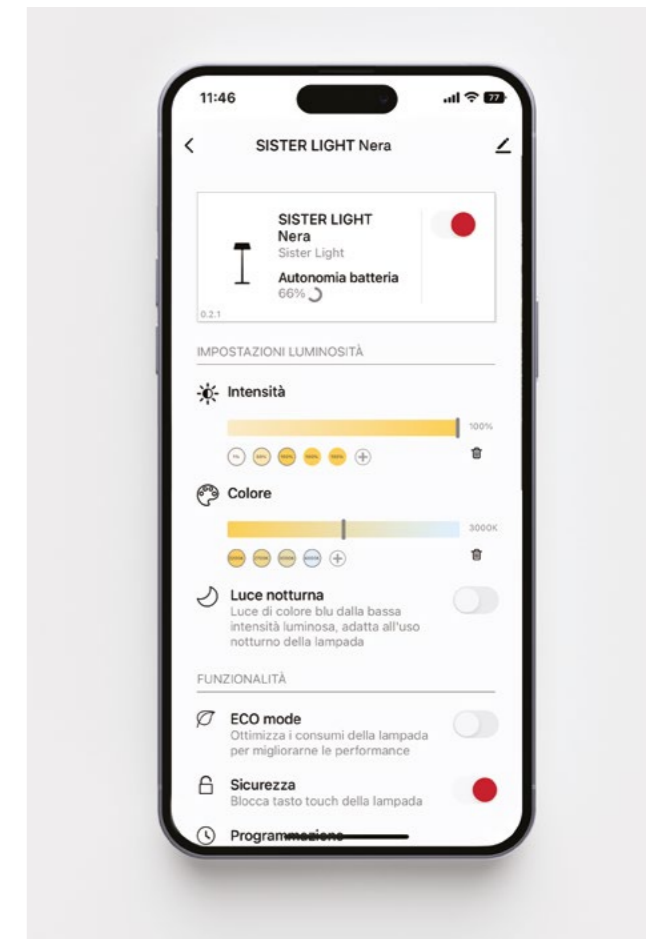

(* Zafferano Lighting App

- Creare e controllare gruppi di lampade
- Dimmer 1-100 con possibilità di creare step personalizzati
- Bianco dinamico (2200K-4000K) con possibilità di creare step personalizzati
- Disabilitazione del "touch" di controllo
- Controllo del livello di carica della batteria
- Timer spegnimento lampada
- Luce notturna
- Eco-Mode
- Disabilitazione del LED di stato
- Definizione tempo di connessione al Wi-Fi
- Modalità emergenza
- Grouping lamps for all-at-once control
- Dimming 1-100 and preset custom dim levels
- Tunable Dynamic White (2200K-4000K) and preset custom color temperature levels
- Disabling touch control
- Monitoring battery charge level
- Time programming (lamp off)
- Activating night light
- Activating Eco Mode
- Disabling status LED
- Wi-Fi connection time-setting
- Activating Emergency Mode



Download Zafferano Lighting App



Sister Light Wi-Fi
table lamp ivory → LD108013



Sister Light Wi-Fi
wall lamp copper → LD1082R3



Sister Light Wi-Fi
table lamp mini gold → **LD108103**



Sister Light Wi-Fi lamp with peg
pearly white → **LD1083B3**

Dati tecnici

Technical data

LED TOUCH DIMMER

2200-2700-3000-4000 K | CRI>90

250-275-296-338 lm | 3,2 W | IP65

5 Vdc max 2A



Corpo in alluminio anodizzato spazzolato (oro, rame, verde) oppure verniciato (bianco perlato, nero perlato, avorio)
Brushed anodized (gold, copper, green) or painted aluminum body (pearly white, pearly black, ivory)

Diffusore in policarbonato prismatico
Prismatic polycarbonate diffuser

Adatta all'uso esterno (lampada IP65) e interno (lampada su base di ricarica IP20)

Suitable for outdoor (lamp IP65) and indoor use (lamp on charging base IP20)

Resistenza agli urti (IK07) e alla nebbia salina (1500h)
Impact resistance (IK07) and salt spray resistance (1500h)

Durata 8 - 58 h, in base alla regolazione del flusso luminoso e alle impostazioni del Wi-Fi
Battery lasts 8 - 58 h, depending on the luminous flux and Wi-Fi setting

Tempo di ricarica a 2A: 5 h
Charging time at 2A: 5 h

Pacco batteria al litio ricaricabile e sostituibile
Rechargeable and replaceable lithium battery pack

AVVERTENZE / REMARKS

Per poter funzionare, la lampada deve essere collegata a una rete Wi-Fi con frequenza 2,4 GHz.
In order to work, the lamp must be connected to a 2.4 GHz frequency Wi-Fi network.

Firmware del dispositivo aggiornabile da remoto.
Remotely upgradable device firmware.

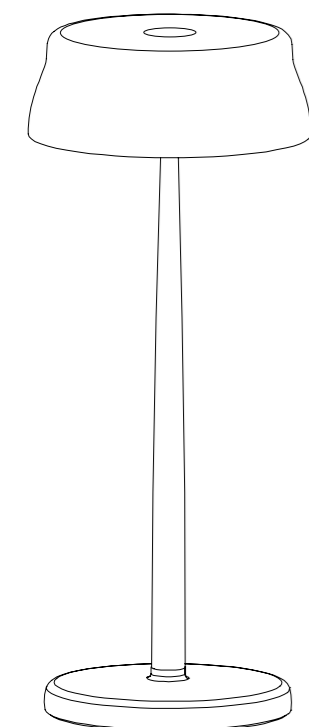

Ø 13,2 x 33 cm
Ø 5,2 x 13 in

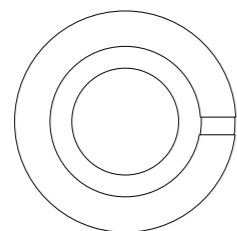

Ø 11,3 cm
Ø 4,4 in

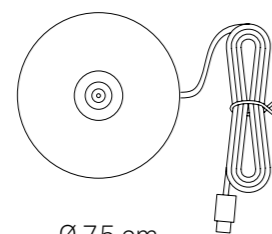

Ø 7,5 cm
Ø 3 in

Componenti inclusi

Components included

Base di ricarica a contatto
Contact charging base

Adattatore per base di ricarica a contatto
Contact charging base adapter

Accessori non inclusi

Accessories not included

Caricatore / Charger
100-240 V | USB Type A
LD0300UC

Finiture

Finishes



LD108003
Oro / Gold



LD1080R3
Rame / Copper



LD1080V3
Verde / Green



LD1080B3
Bianco perlato / Pearly white
RAL 9010



LD1080D3
Nero perlato / Pearly black
RAL 9011



LD1080I3
Avorio / Ivory
RAL 1015

Dati tecnici

Technical data

LED TOUCH DIMMER

2200-2700-3000-4000 K | CRI>90
250-275-296-338 lm | 3,2 W | IP65
5 Vdc max 2A



Corpo in alluminio anodizzato spazzolato
(oro, rame, verde) oppure verniciato
(bianco perlato, nero perlato, avorio)
Brushed anodized (gold, copper, green) or painted
aluminum body (pearly white, pearly black, ivory)

Diffusore in policarbonato prismatico
Prismatic polycarbonate diffuser

Adatta all'uso esterno (lampada IP65) e interno
(lampada su base di ricarica IP20)
Suitable for outdoor (lamp IP65) and indoor use
(lamp on charging base IP20)

Resistenza agli urti (IK07) e alla nebbia salina (1500h)
Impact resistance (IK07) and salt spray resistance
(1500h)

Durata 8 - 58 h, in base alla regolazione del flusso
luminoso e alle impostazioni del Wi-Fi
Battery lasts 8 - 58 h, depending on the luminous
flux and Wi-Fi setting

Tempo di ricarica a 2A: 5 h
Charging time at 2A: 5 h

Pacco batteria al litio ricaricabile e sostituibile
Rechargeable and replaceable lithium battery pack

AVVERTENZE / REMARKS

Per poter funzionare, la lampada deve essere
collegata a una rete Wi-Fi con frequenza 2,4 GHz.
In order to work, the lamp must be connected
to a 2.4 GHz frequency Wi-Fi network.

Firmware del dispositivo aggiornabile da remoto.
Remotely upgradable device firmware.

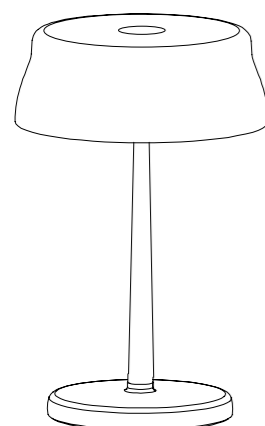

Ø 13,2 x 17 cm
Ø 5,2 x 6,7 in

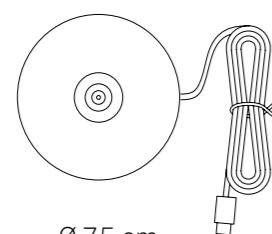

Ø 7,5 cm
Ø 3 in

Componenti inclusi

Components included

Base di ricarica a contatto
Contact charging base

Accessori non inclusi

Accessories not included

Caricatore / Charger
100-240 V | USB Type A
LD0300UC

Finiture

Finishes

**LD108103**

Oro / Gold

**LD1081R3**

Rame / Copper

**LD1081V3**

Verde / Green

**LD1081B3**Bianco perlato / Pearly white
RAL 9010**LD1081D3**Nero perlato / Pearly black
RAL 9011**LD1081I3**Avorio / Ivory
RAL 1015

Dati tecnici

Technical data

LED TOUCH DIMMER

2200-2700-3000-4000 K | CRI>90
250-275-296-338 lm | 3,2 W | IP65
5 Vdc max 2A



Corpo in alluminio anodizzato spazzolato
(oro, rame, verde) oppure verniciato
(bianco perlato, nero perlato, avorio)
Brushed anodized (gold, copper, green) or painted
aluminum body (pearly white, pearly black, ivory)

Diffusore in policarbonato prismatico
Prismatic polycarbonate diffuser

Adatta all'uso esterno (lampada IP65) e interno
(lampada su base di ricarica IP20)
Suitable for outdoor (lamp IP65) and indoor use
(lamp on charging base IP20)

Resistenza agli urti (IK07) e alla nebbia salina (1500h)
Impact resistance (IK07) and salt spray resistance
(1500h)

Durata 8 - 58 h, in base alla regolazione del flusso
luminoso e alle impostazioni del Wi-Fi
Battery lasts 8 - 58 h, depending on the luminous
flux and Wi-Fi setting

Tempo di ricarica a 2A: 5 h
Charging time at 2A: 5 h

Pacco batteria al litio ricaricabile e sostituibile
Rechargeable and replaceable lithium battery pack

AVVERTENZE / REMARKS

Per poter funzionare, la lampada deve essere
collegata a una rete Wi-Fi con frequenza 2,4 GHz.
In order to work, the lamp must be connected
to a 2.4 GHz frequency Wi-Fi network.

Firmware del dispositivo aggiornabile da remoto.
Remotely upgradable device firmware.

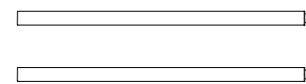
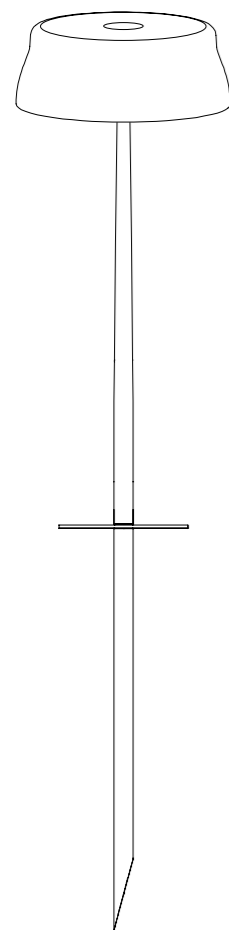

25 cm
9,8 in

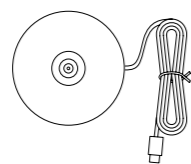

Ø 7,5 cm
Ø 3 in

Ø 13,2 x 58-83-106 cm
Ø 5,2 x 22,8-32,6-41,7 in

Componenti inclusi

Components included

Base di ricarica a contatto
Contact charging base
Stelo (2 pz.) / Stem (2 pcs.)

Accessori non inclusi

Accessories not included

Caricatore / Charger
100-240 V | USB Type A
LD0300UC

Finiture

Finishes



LD1083O3
Oro / Gold



LD1083R3
Rame / Copper



LD1083V3
Verde / Green



LD1083B3
Bianco perlato / Pearly white
RAL 9010



LD1083D3
Nero perlato / Pearly black
RAL 9011



LD1083I3
Avorio / Ivory
RAL 1015

Dati tecnici

Technical data

LED TOUCH DIMMER

2200-2700-3000-4000 K | CRI>90
250-275-296-338 lm | 3,2 W | IP65
5 Vdc max 2A



Corpo in alluminio anodizzato spazzolato
(oro, rame, verde) oppure verniciato
(bianco perlato, nero perlato, avorio)
Brushed anodized (gold, copper, green) or painted
aluminum body (pearly white, pearly black, ivory)

Diffusore in policarbonato prismatico
Prismatic polycarbonate diffuser

Adatta all'uso esterno (lampada IP65) e interno
(lampada su base di ricarica IP20)
Suitable for outdoor (lamp IP65) and indoor use
(lamp on charging base IP20)

Resistenza agli urti (IK07) e alla nebbia salina (1500h)
Impact resistance (IK07) and salt spray resistance
(1500h)

Durata 8 - 58 h, in base alla regolazione del flusso
luminoso e alle impostazioni del Wi-Fi
Battery lasts 8 - 58 h, depending on the luminous
flux and Wi-Fi setting

Tempo di ricarica a 2A: 5 h
Charging time at 2A: 5 h

Pacco batteria al litio ricaricabile e sostituibile
Rechargeable and replaceable lithium battery pack

AVVERTENZE / REMARKS

Per poter funzionare, la lampada deve essere
collegata a una rete Wi-Fi con frequenza 2,4 GHz.
In order to work, the lamp must be connected
to a 2.4 GHz frequency Wi-Fi network.

Firmware del dispositivo aggiornabile da remoto.
Remotely upgradable device firmware.

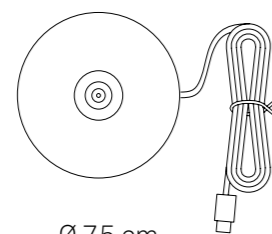
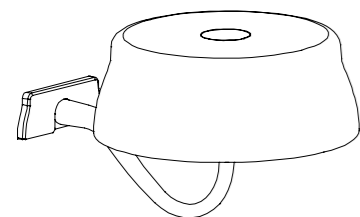

9,8 x 13,2 x 18 cm
3,5 x 5,1 x 7,1 in

Ø 7,5 cm
Ø 3 in

Componenti inclusi

Components included

Base di ricarica a contatto
Contact charging base

Accessori non inclusi

Accessories not included

Caricatore / Charger
100-240 V | USB Type A
LD0300UC

Finiture

Finishes



LD108203
Oro / Gold



LD1082R3
Rame / Copper



LD1082V3
Verde / Green



LD1082B3
Bianco perlato / Pearly white
RAL 9010



LD1082D3
Nero perlato / Pearly black
RAL 9011



LD1082I3
Avorio / Ivory
RAL 1015

Pencil

Design Federico de Majo

Sospesa magicamente
abbracciata o libera
sembri sostenere il peso del tronco.
Esile presenza
ti presti a giocare
in una luminosa danza.

Magically suspended
embraced or free
you appear to be bearing the weight of a trunk.
Slender presence
you play along
in a luminous dance.

MODULO LUCE / CARICABATTERIE / BASE DI STAZIONAMENTO E RICARICA / BASE DI STAZIONAMENTO ROTANTE / SUPPORTI TAVOLO /
SUPPORTI PARETE ORIZZONTALE / SUPPORTO PARETE VERTICALE / SUPPORTO SOSPENSIONE VERTICALE / SUPPORTI SOSPENSIONE
ORIZZONTALE LIGHTING MODULE / BATTERY CHARGER / DOCKING AND CHARGING STATION / ROTATING DOCKING STATION / TABLE BASES
/ HORIZONTAL WALL LAMP BRACKETS / VERTICAL WALL LAMP KIT / VERTICAL SUSPENSION KIT / HORIZONTAL SUSPENSION KIT



Pencil lighting module large white → **LD0802B3**
Pencil lighting module medium white → **LD0801B3**
Pencil lighting module small white → **LD0800B3**
Cansiglio forest
Treviso, Italy



Progetto selezionato dall'Osservatorio Permanente del Design ADI per ADI Design Index 2022.

Project selected by the ADI Permanent Design Observatory for ADI Design Index 2022.

Pencil è un sistema di illuminazione composto da un modulo luminoso a batteria portatile e ricaricabile e dagli accessori dedicati che lo trasformano in lampada da terra, tavolo, parete e a sospensione. Il modulo Pencil può dunque usato nel suo alloggiamento fisso, ma anche rimosso, portato con sé da un ambiente all'altro, e usato autonomamente: continuerà a funzionare a lungo, fino all'esaurimento della carica accumulata (fino a 58 ore). La sorgente a LED produce una luce intensa e ben direzionata, che grazie alla dimmerazione a 4 step e alla funzione di selezione della temperatura di colore consente di calibrare con precisione l'illuminazione di spazi pubblici e privati, anche outdoor.

Pencil is a lighting system consisting of a rechargeable battery-powered cordless light module, and the dedicated accessories that transform it into a wall, pendant, and floor/table lamp. The module can therefore be used in its fixed housing, but also removed and carried from one place to another, and used independently: it will continue to function for a long time, until the accumulated charge power runs out (up to 58 h). The LED source produces a bright, well-directed light, which - thanks to the 4-step dimming and the color temperature selection functions - provides the most appropriate illumination for public and private spaces, also outdoors.

Pencil lighting module medium
corten → **LD0801R3**
Glamping Canonici, Venice



Pencil

Modulo luce Lighting module



Video Pencil



Pencil è un modulo luminoso a batteria, portatile e ricaricabile, disponibile in tre misure. All'estremità del modulo è presente un controllo "touch", che permette l'accensione, la regolazione dell'intensità luminosa (dimmerazione a 4 step) e la selezione della temperatura di colore della luce tra 2700K, 3150K e 4000K. Grazie a un alto indice di protezione, il modulo luminoso è utilizzabile anche all'esterno; resiste inoltre alla nebbia salina (1500 h). Possiede un sistema di controllo elettronico che monitora l'autonomia residua e garantisce un flusso luminoso costante fino all'esaurimento della batteria, permettendo di ottimizzare le ricariche ed effettuarle sempre in maniera corretta. Il modulo Pencil può essere ricaricato in due modi: direttamente tramite caricabatterie (pag. 182); o a contatto sulla base di stazionamento, la quale può essere utilizzata anche solo come alloggio del modulo, per un utilizzo come lampada da terra o da tavolo. Caricabatterie non incluso.

Pencil is a battery-operated portable and rechargeable lighting module, available in three sizes. A "touch" control on one end allows switching on/off, dimming (4-step: 100%, 60%, 30%, 6%) and selecting the color temperature of the light (2700K, 3150K or 4000K). It is suitable for both indoor and outdoor use and salt spray resistant (1500 h). An electronic control system monitors the remaining autonomy and ensures a constant luminous flux until the battery runs out. Recharging is therefore optimized and always properly done. The lighting module can be recharged in two ways: either with the battery charger (pg. 182) or in the docking station, connected to a battery charger. The battery charger is not included.

Pencil lighting module medium white
+ vertical suspension kit
→ LD0801B3 + LD0811B3

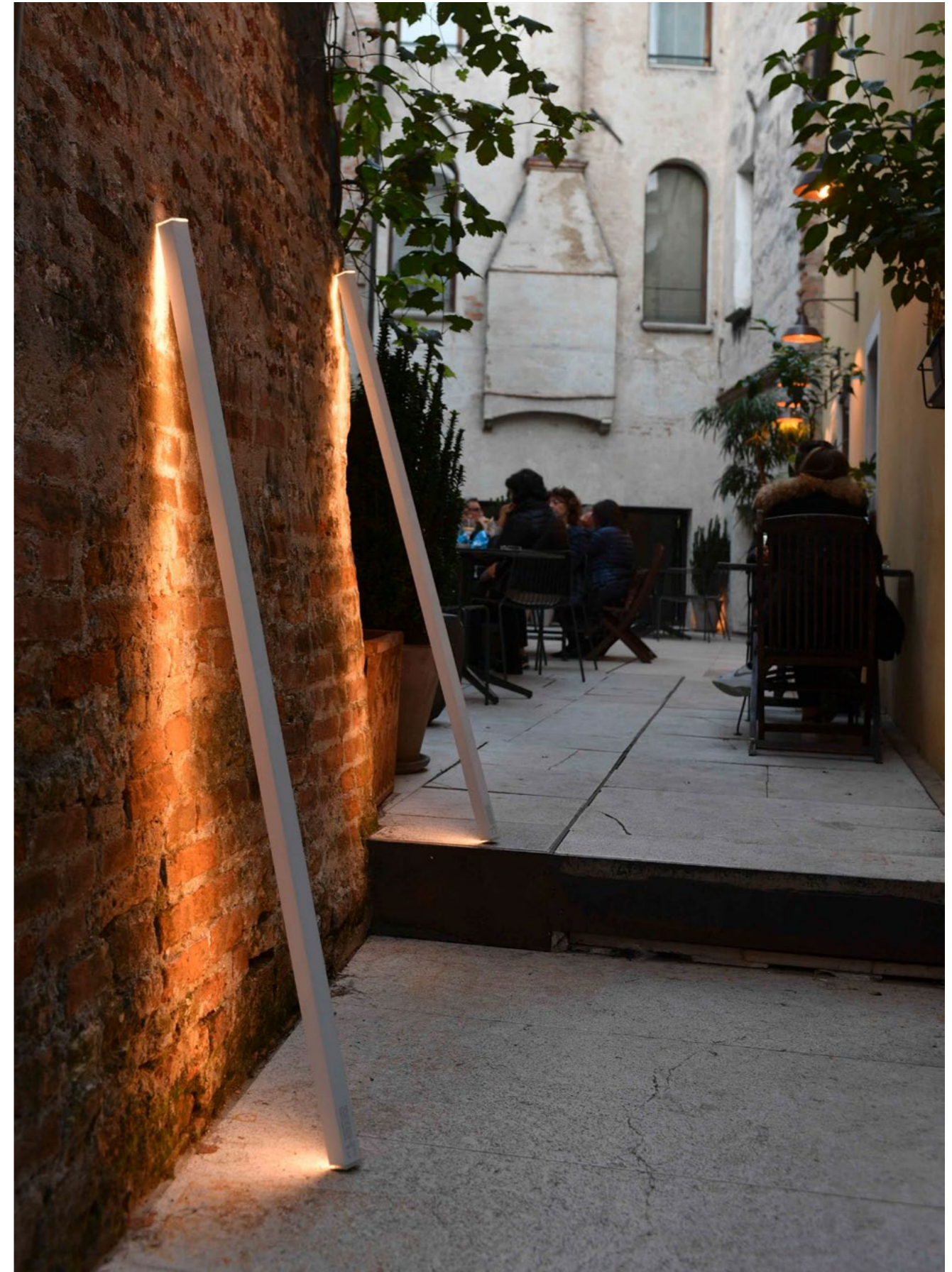

Dati tecnici

Technical data

LED TOUCH DIMMER | 2700-3150-4000K | CRI>90 | 6W | 580-650-680lm | **IP65** | 19 Vdc max 2,5 A

LED TOUCH DIMMER | 2700-3150-4000K | CRI>90 | 12W | 1160-1300-1360lm | **IP65** | 19 Vdc max 2,5 A

LED TOUCH DIMMER | 2700-3150-4000K | CRI>90 | 18W | 1740-1950-2040lm | **IP65** | 19 Vdc max 2,5 A

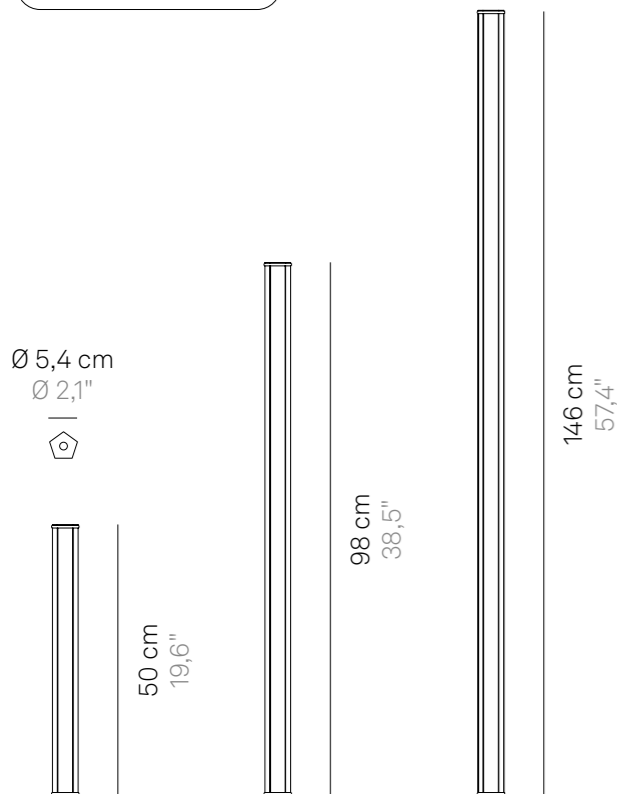

Pacchi batterie al litio ricaricabili e sostituibili
Rechargeable and replaceable lithium battery packs

Durata 8 - 58 h, in base alla regolazione del flusso luminoso

Battery lasts 8 - 58 h, depending on the luminous flux setting.

Ricarica con connettore 3.5/1.3, oppure a contatto (quando usato su base ricarica)

Rechargeable with a 3.5/1.3 connector, or by contact (when used with the charging base)

Tempi di ricarica a 3,16A: 6/9/12 h (rispettivamente per misura piccola/media/grande)

Recharging times at 3.16A: 6/9/12 h (for small/medium/ large size respectively)

Corpo in estrusione d'alluminio verniciato
Painted extruded aluminum fixture

Diffusore in policarbonato opale satinato
Satin opal polycarbonate diffuser

Adatta all'uso esterno (lampada IP65) e interno (lampada su base di ricarica IP20)

Suitable for outdoor (lamp IP65) and indoor use (lamp on charging base IP20)

Resistenza agli urti (IK07) e alla nebbia salina (1500h)
Impact resistance (IK07) and salt spray resistance (1500h)

Avvertenze

Remarks

Con gli accessori dedicati, il modulo luminoso Pencil può diventare lampada da terra, tavolo, parete e a sospensione.

Thanks to its dedicated accessories, the lighting module can become a floor, table, wall and pendant lamp.

Componente non incluso

Component not included

Caricabatterie 19Vdc max 2,5A *
Charger 19Vdc max 2,5A *

* Componente necessario, da acquistare separatamente

* Necessary accessory, yet it must be purchased separately

Finiture

Finishes



Bianco
/ White
RAL 9003

Corten

Grigio scuro
/ Dark grey
RAL 7012

Small

LD0800B3

LD0800R3

LD0800G3

Medium

LD0801B3

LD0801R3

LD0801G3

Large

LD0802B3

LD0802R3

LD0802G3

Completa la tua lampada

Complete your lamp

Caricabatterie → pg. 204
Battery charger → pg. 204

 Supporti parete orizzontale → pg. 212
Horizontal wall lamp brackets → pg. 212

 Base di stazionamento e ricarica → pg. 206
Docking and charging station → pg. 206

 Supporto parete verticale → pg. 214
Vertical wall lamp kit → pg. 214

 Base di stazionamento rotante → pg. 208
Rotating docking station → pg. 208

 Supporto sospensione verticale → pg. 216
Vertical suspension kit → pg. 216

 Supporti tavolo → pg. 210
Table bases → pg. 210

 Supporti sospensione orizzontale → pg. 218
Horizontal suspension kit → pg. 218

Pencil

Caricabatterie Battery charger



LD0800CS

Dati tecnici

Technical data

47,5W • 100-240V • 50-60Hz
19Vdc max 2,5A

CE IP20

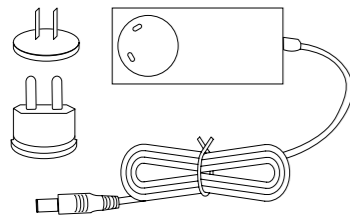

Il caricabatterie permette di ricaricare Pencil in due modi: collegando il cavo (fig. 1) direttamente al modulo luminoso; oppure collegando il cavo alla base di stazionamento e ricarica in cui il modulo viene posizionato (fig. 2). È un componente necessario, da acquistare separatamente: la lunga durata della batteria di Pencil consente infatti di utilizzare un solo caricabatterie per caricare più moduli. Ha una forma compatta, un cavo con attacco 3,5/1,3 e una spina intercambiabile per EU/ USA in dotazione; funziona a 100-240V.

The battery charger allows the recharging of Pencil in two ways: either by connecting cable directly to the lighting module (fig. 1); or by connecting the cable to the docking station where the module is placed (fig. 2). It is a necessary accessory, yet it must be purchased separately: the long-lasting battery of Pencil enables to use just one battery charger to charge multiple lighting modules. It has a compact design, a cable with 3.5/1.3 connection and an interchangeable plug suitable for EU / USA standards; dual voltage 100-240V.



Pencil

Base di stazionamento e ricarica*

Docking and charging station*

* Solo se connesso al caricatore

* Only if connected with the charger



Dati tecnici

Technical data

19Vdc max 3,16A

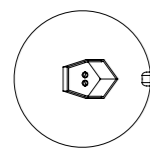
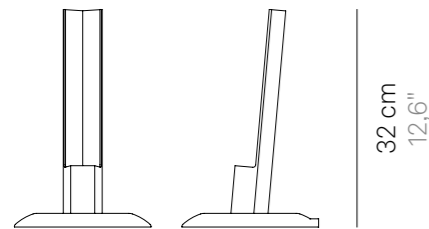

Ø 20 cm
Ø 7,8"

Finiture

Finishes



LD0810B3

Bianco
/ White
RAL 9003



LD0810R3

Corten



LD0810G3

Grigio scuro
/ Dark grey
RAL 7012

Corpo in alluminio verniciato
Painted aluminum fixture

Componente non incluso
Component not included

Caricabatterie → pag. 204
Charger → pg. 204

Accessorio con doppia funzione: è principalmente una base di stazionamento, che trasforma Pencil in lampada da terra o da tavolo; collegato al caricabatterie, diventa una base di ricarica a contatto per il modulo luminoso. Il modulo luminoso può essere usato nel suo alloggiamento fisso, ma anche rimosso e portato con sé da un ambiente all'altro.

A dual-function accessory: it is mainly used as a docking station, turning the lighting module Pencil into a floor or table lamp. Connected to the battery charger, it becomes a contact charging base for the lighting module. The lighting module can be used in its fixed housing, or detached and carried from one place to another.

Pencil lighting module large white
+ docking station white
→ **LD0802B3 + LD0810B3**
Osteria Stasera Corder - Treviso, Italy
Photo phEsci Francesco Esci



Pencil

Base di stazionamento rotante*

Rotating docking station*

* Non assolve la funzione di ricarica

* Not a charging station



Dati tecnici

Technical data

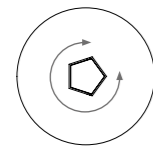
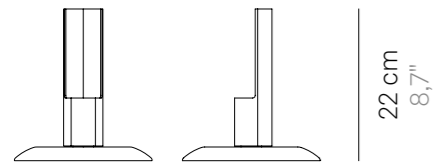

Ø 20 cm
Ø 7,8"

Finiture

Finishes



LD0816B3

Bianco
/ White
RAL 9003



LD0816R3

Corten



LD0816G3

Grigio scuro
/ Dark grey
RAL 7012

Corpo in alluminio verniciato
Painted aluminum fixture

Base di stazionamento che trasforma Pencil in lampada da terra o da tavolo. Questo accessorio mantiene il modulo luminoso in posizione perpendicolare rispetto al piano di appoggio, e ne permette la rotazione a 360° sull'asse longitudinale, in entrambi i sensi. Il modulo luminoso può essere usato nel suo alloggiamento fisso, ma anche rimosso e portato con sé da un ambiente all'altro. Questa base di stazionamento non assolve la funzione di ricarica.

A docking station that turns Pencil into a floor lamp or table lamp. This accessory keeps the lighting module in a perpendicular position in relation to the supporting surface, thereby allowing it to rotate 360° on the longitudinal axis, in both directions. The lighting module can be used in its fixed housing or detached and carried from one place to another. This docking station does not charge the lamp.



Pencil

Supporti tavolo Table bases



Dati tecnici Technical data

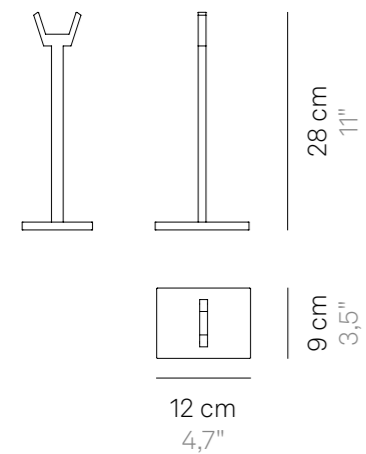

Finiture Finishes



LD081400
Trasparente / Transparent

Supporti in PMMA trasparente
Transparent PMMA structure

Elementi che trasformano Pencil in una lampada da tavolo. Il modulo luminoso può essere usato nel suo supporto, ma anche rimosso e portato con sé da un ambiente all'altro.

Elements that turn Pencil into a table lamp. The lighting module can be used in its fixed housing or detached and carried from one place to another.



Pencil lighting module small white
+ table bases
→ LD0800B3 + LD081400

Pencil

Supporti parete orizzontale Horizontal wall lamp brackets



Dati tecnici Technical data

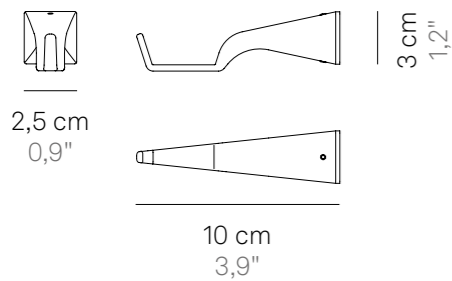

Finiture Finishes



LD0813B3
Bianco
/ White
RAL 9003

LD0813R3
Corten

LD0813G3
Grigio scuro
/ Dark grey
RAL 7012

Supporti in pressofusione d'alluminio verniciato
Painted die-cast aluminum elements

Supporti che trasformano Pencil in una lampada da parete orizzontale. Il modulo luminoso può essere usato nel suo supporto fisso, ma anche rimosso e portato con sé da un ambiente all'altro.

Brackets that turn Pencil into a horizontal wall lamp. The lighting module can be used in its fixed housing or detached and carried from one place to another.



Pencil lighting module small white
+ horizontal wall lamp brackets white
→ **LD0800B3 + LD0813B3**

Pencil

Supporto parete verticale Vertical wall lamp kit



Dati tecnici Technical data

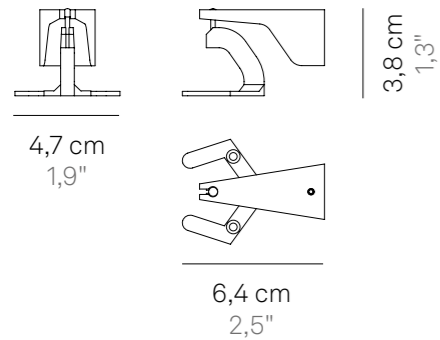

Finiture Finishes



LD0815B3
Bianco
/ White
RAL 9003



LD0815R3
Corten



LD0815G3
Grigio scuro
/ Dark grey
RAL 7012

Supporto in pressofusione d'alluminio
verniciato con particolari cromati
Painted die-cast aluminum element with
chromed details

Elemento che trasforma Pencil in una lampada da parete verticale, che ruota sul proprio asse longitudinale a 360°, in entrambi i sensi. Il modulo luminoso può essere usato nel suo supporto fisso, ma anche rimosso e portato con sé da un ambiente all'altro.

Element that turns Pencil into a vertical wall lamp, rotating on its longitudinal axis by 360°, in both directions. The lighting module can be used in its fixed housing or detached and carried from one place to another.



Pencil lighting module medium white
+ vertical wall lamp kit white
→ **LD0801B3** + **LD0815B3**

Pencil

Supporto sospensione verticale

Vertical suspension kit



Dati tecnici

Technical data

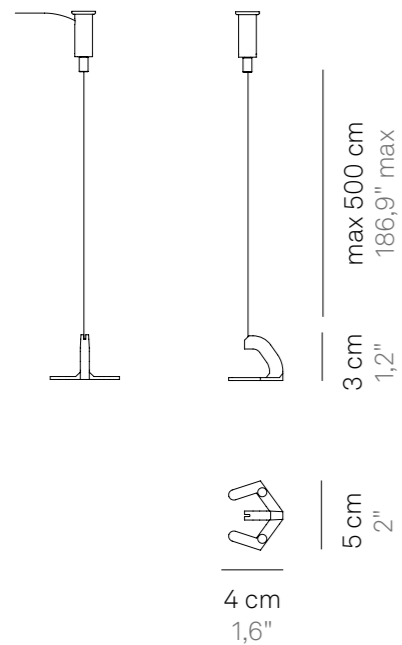

Finiture

Finishes



LD0811B3
Bianco
/ White
RAL 9003



LD0811R3
Corten



LD0811G3
Grigio scuro
/ Dark grey
RAL 7012

Supporto in pressofusione d'alluminio verniciato con particolari cromati
Painted die-cast aluminum element with chromed details

Componenti inclusi

Components included

Cavo in acciaio e staffe
Steel cable and brackets

Elemento che trasforma Pencil in una lampada a sospensione verticale. Il modulo luminoso può essere usato nel suo supporto fisso, ma anche rimosso e portato con sé da un ambiente all'altro.

Element that turns Pencil into a vertical suspension lamp. The lighting module can be used in its fixed housing, or detached and carried from one place to another.



Pencil lighting module small dark grey
+ vertical suspension kit dark grey
→ **LD0800G3 + LD0811G3**

Pencil

Supporti sospensione orizzontale

Horizontal suspension kit



Dati tecnici Technical data

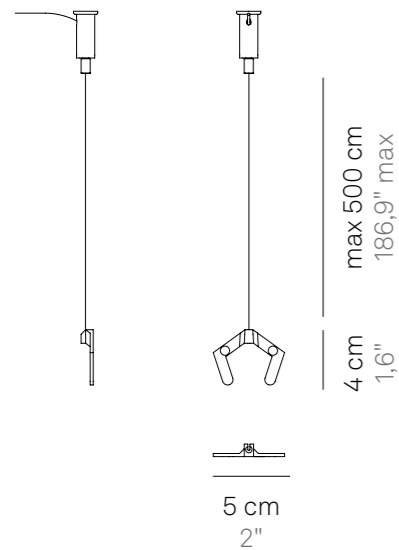

Finiture Finishes



LD0812B3
Bianco
/ White
RAL 9003

LD0812R3
Corten

LD0812G3
Grigio scuro
/ Dark grey
RAL 7012

Supporto in pressofusione d'alluminio
verniciato con particolari cromati
Painted die-cast aluminum element with
chromed details

Componenti inclusi Components included

Cavo in acciaio e staffe
Steel cable and brackets

Elementi che trasformano Pencil in una lampada a sospensione orizzontale a luce diretta. Il modulo luminoso può essere usato nel suo supporto fisso, ma anche rimosso e portato con sé da un ambiente all'altro.

Elements that turn Pencil into a horizontal suspension lamp. The lighting module can be used in its fixed housing or detached and carried from one place to another.



Pencil lighting module medium dark grey
+ horizontal suspension kit dark grey →
LD0801BG + LD0812G3

Amelie

Design Sara Moroni



Amelie è una collezione di lampade a batteria, portatili e ricaricabili, che comprende le tipologie da tavolo, terra, parete, a sospensione e con picchetto. Le lampade da tavolo, terra, parete e con picchetto vengono fornite con un tappo in silicone e un gancio, che permettono di trasformarli in una sospensione. Un controllo "touch" presente nella parte superiore della testa permette l'accensione, la regolazione dell'intensità luminosa e la selezione della temperatura di colore della luce tra 2200 K, 2700 K e 3000 K. Grazie a un alto indice di protezione, le lampade della collezione sono utilizzabili anche all'esterno. Sono dotate di base di ricarica a contatto. Caricabatterie non incluso.

Amelie is a collection of portable, rechargeable battery-operated lamps that includes the following models: table, floor, wall and suspension lamps, and lamp with peg. The table, floor and wall lamps and lamp with peg are supplied with a silicone cap and a hook, so that they can be transformed into a suspension lamp. On the head, a touch sensor allows you to switch it on, adjust the luminous intensity and select the color temperature of the light to 2200 K, 2700 K or 3000 K. With the high IP rating, the lamps can also be used outdoors. The lamps come with a contact charging base; battery charger not included.



Amelie table lamp
leaf green → LD1090V3



Amelie suspension lamp
leaf green → **LD1091V3**



Amelie wall lamp
white → **LD1092B3**



Amelie lamp with peg
terracotta → **LD1094T3**



Amelie floor lamp
white → **LD1096B3**

Dati tecnici

Technical data

LED TOUCH DIMMER

2200-2700-3000 K | CRI>80
253-300-308 lm | 3 W | IP65
5 Vdc max 1A



Corpo in pressofusione di alluminio verniciato
Painted die-cast aluminum body

Schermo diffusore in policarbonato opale
Opal polycarbonate diffuser

Adatta all'uso esterno (lampada IP65) e interno
(lampada su base di ricarica IP20)
Suitable for outdoor (lamp IP65) and indoor use
(lamp on charging base IP20)

Durata di circa 10 h alla massima potenza
Battery lasts about 10 h at full power

Tempo di ricarica a 1A: 6 h
Charging time at 1A: 6 h

Pacco batteria al litio ricaricabile e sostituibile
Rechargeable and replaceable lithium battery pack

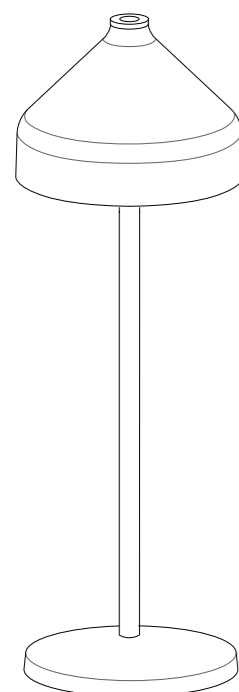

Ø 12 x 34 cm
Ø 4,7 x 13,3 in

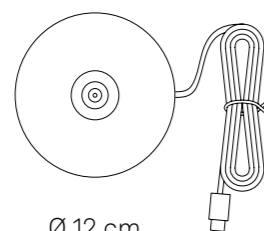

Ø 12 cm
Ø 4,7 in

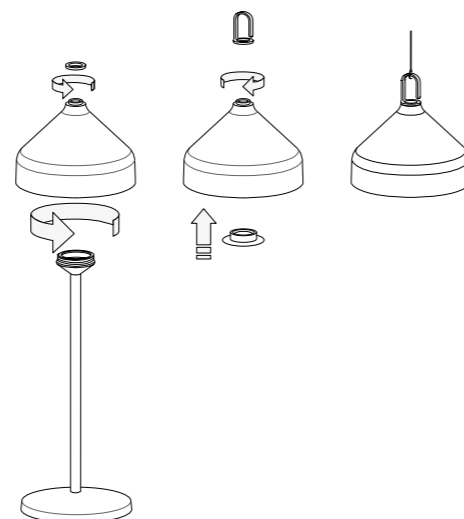
**Componenti inclusi**

Components included

Base di ricarica a contatto
Contact charging base

Accessorio per utilizzo a sospensione
(tappo in silicone e gancio)

Accessories to use as a suspension lamp
(silicon cap and hook)

Accessori non inclusi

Accessories not included

Caricatore / Charger
100-240 V | USB Type A
LD0490UA

Finiture

Finishes



LD1090B3
Bianco / White
RAL 9016



LD1090D3
Nero / Black
RAL 9011



LD1090V3
Verde foglia / Leaf green
RAL 150 60 10



LD1090T3
Terracotta
Pantone 49-12 C



Amelie table lamp
terracotta → **LD1090T3**

Dati tecnici

Technical data

LED TOUCH DIMMER

2200-2700-3000 K | CRI>80

253-300-308 lm | 3 W | IP65

5 Vdc max 1A



Corpo in pressofusione di alluminio verniciato

Painted die-cast aluminum body

Schermo diffusore in policarbonato opale

Opal polycarbonate diffuser

Adatta all'uso esterno (lampada IP65) e interno (lampada su base di ricarica IP20)

Suitable for outdoor (lamp IP65) and indoor use (lamp on charging base IP20)

Durata di circa 10 h alla massima potenza

Battery lasts about 10 h at full power

Tempo di ricarica a 1A: 6 h

Charging time at 1A: 6 h

Pacco batteria al litio ricaricabile e sostituibile

Rechargeable and replaceable lithium battery pack

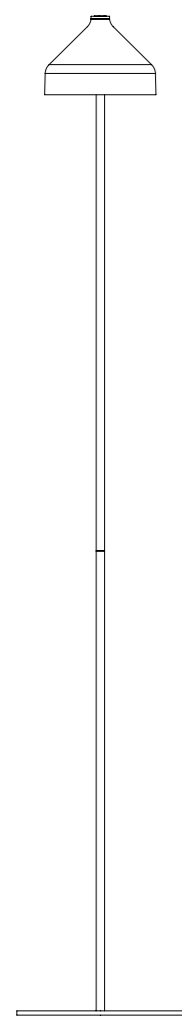
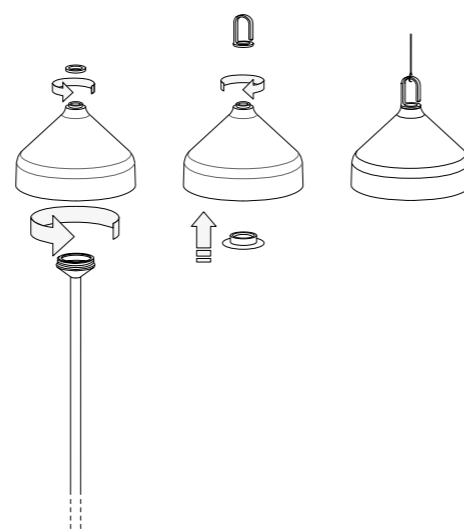

Ø 20 x 120 cm
Ø 7,8 x 47 in

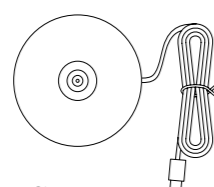

Ø 12 cm
Ø 4,7 in

Componenti inclusi

Components included

Base di ricarica a contatto

Contact charging base

Accessorio per utilizzo a sospensione

(tappo in silicone e gancio)

Accessories to use as a suspension lamp

(silicon cap and hook)

Accessori non inclusi

Accessories not included

Caricatore / Charger

100-240 V | USB Type A

LD0490UA

Finiture

Finishes



LD1096B3
Bianco / White
RAL 9016

LD1096D3
Nero / Black
RAL 9011

LD1096V3
Verde foglia / Leaf green
RAL 150 60 10

LD1096T3
Terracotta
Pantone 49-12 C

Dati tecnici

Technical data

LED TOUCH DIMMER

2200-2700-3000 K | CRI>80

253-300-308 lm | 3 W | IP65

5 Vdc max 1A

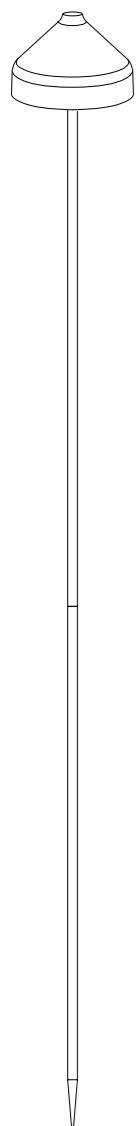

Ø 12 x 120 cm
Ø 4,7 x 47 in

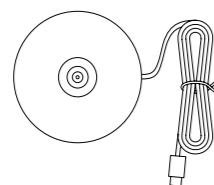

Ø 12 cm
Ø 4,7 in

Corpo in pressofusione di alluminio verniciato

Painted die-cast aluminum body

Schermo diffusore in policarbonato opale

Opal polycarbonate diffuser

Adatta all'uso esterno (lampada IP65) e interno (lampada su base di ricarica IP20)

Suitable for outdoor (lamp IP65) and indoor use (lamp on charging base IP20)

Durata di circa 10 h alla massima potenza

Battery lasts about 10 h at full power

Tempo di ricarica a 1A: 6 h

Charging time at 1A: 6 h

Pacco batteria al litio ricaricabile e sostituibile

Rechargeable and replaceable lithium battery pack

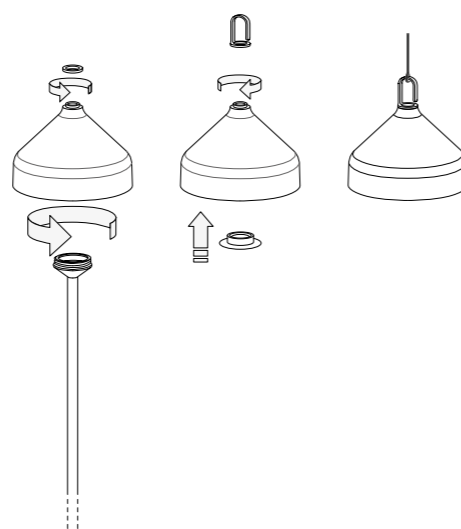
**Componenti inclusi**

Components included

Base di ricarica a contatto

Contact charging base

Accessorio per utilizzo a sospensione (tappo in silicone e gancio)

Accessories to use as a suspension lamp (silicon cap and hook)

Accessori non inclusi

Accessories not included

Caricatore / Charger

100-240 V | USB Type A

LD0490UA

Finiture

Finishes



LD1094B3
Bianco / White
RAL 9016



LD1094D3
Nero / Black
RAL 9011



LD1094V3
Verde foglia / Leaf green
RAL 150 60 10



LD1094T3
Terracotta
Pantone 49-12 C

Dati tecnici

Technical data

LED TOUCH DIMMER

2200-2700-3000 K | CRI>80
253-300-308 lm | 3 W | IP65
5 Vdc max 1A



Corpo in pressofusione di alluminio verniciato
Painted die-cast aluminum body

Schermo diffusore in policarbonato opale
Opal polycarbonate diffuser

Adatta all'uso esterno (lampada IP65) e interno
(lampada su base di ricarica IP20)
Suitable for outdoor (lamp IP65) and indoor use
(lamp on charging base IP20)

Durata di circa 10 h alla massima potenza
Battery lasts about 10 h at full power

Tempo di ricarica a 1A: 6 h
Charging time at 1A: 6 h

Pacco batteria al litio ricaricabile e sostituibile
Rechargeable and replaceable lithium battery pack

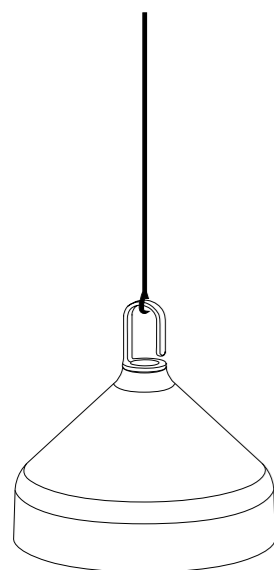

Ø 12 x 12 cm
Ø 4,7 x 4,7 in

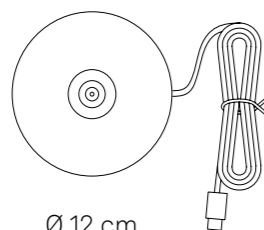

Ø 12 cm
Ø 4,7 in

Componenti inclusi

Components included

Base di ricarica a contatto
Contact charging base

Tappo in silicone e gancio
Silicon cap and hook

Accessori non inclusi

Accessories not included

Caricatore / Charger
100-240 V | USB Type A
LD0490UA

Finiture

Finishes

**LD1091B3**

Bianco / White
RAL 9016

LD1091D3

Nero / Black
RAL 9011

LD1091V3

Verde foglia / Leaf green
RAL 150 60 10

LD1091T3

Terracotta
Pantone 49-12 C



Dati tecnici

Technical data

LED TOUCH DIMMER

2200-2700-3000 K | CRI>80
253-300-308 lm | 3 W | IP65
5 Vdc max 1A



Corpo in pressofusione di alluminio verniciato
Painted die-cast aluminum body

Schermo diffusore in policarbonato opale
Opal polycarbonate diffuser

Adatta all'uso esterno (lampada IP65) e interno
(lampada su base di ricarica IP20)
Suitable for outdoor (lamp IP65) and indoor use
(lamp on charging base IP20)

Durata di circa 10 h alla massima potenza
Battery lasts about 10 h at full power

Tempo di ricarica a 1A: 6 h
Charging time at 1A: 6 h

Pacco batteria al litio ricaricabile e sostituibile
Rechargeable and replaceable lithium battery pack

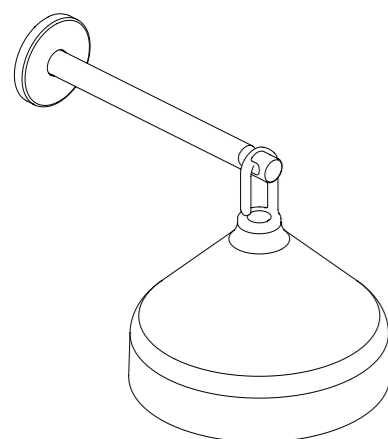

20 x 12 x 14 cm
7,8 x 4,7 x 5,5 in

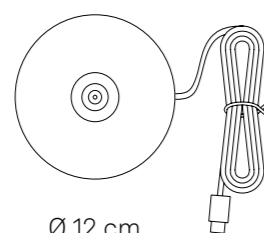

Ø 12 cm
Ø 4,7 in

Componenti inclusi

Components included

Base di ricarica a contatto
Contact charging base

Tappo in silicone e gancio
Silicon cap and hook

Accessori non inclusi

Accessories not included

Caricatore / Charger
100-240 V | USB Type A
LD0490UA

Finiture

Finishes

**LD1092B3**

Bianco / White
RAL 9016

LD1092D3

Nero / Black
RAL 9011

LD1092V3

Verde foglia / Leaf green
RAL 150 60 10

LD1092T3

Terracotta
Pantone 49-12 C



Circe

Tavolo pro

Table lamp pro



Circe è una lampada da tavolo a batteria, portatile e ricaricabile. Nella parte superiore della testa è presente un pulsante che permette l'accensione, la regolazione dell'intensità luminosa e la selezione della temperatura di colore della luce tra 2200 K e 3000 K (bianco dinamico). Grazie ad un alto indice di protezione, la lampada è utilizzabile anche all'esterno (ad eccezione dei modelli con finitura galvanica, dei quali è sconsigliato l'uso continuativo in esterni). È dotata di base di ricarica a contatto. Caricabatterie non incluso.

Circe is a rechargeable battery-powered cordless table lamp. The knob on the top of the lampshade allows switching on/off, dimming, and tuning the color temperature of the light between 2200 K and 3000 K (Dynamic Tunable White). It is suitable for both indoor and outdoor use (except gold and rose gold finishes). Circe comes with a contact charging base; the battery charger is not included.



Circe table lamp
white → LD1005B3



Circe table lamp
corten → **LD1005R3**

Circe table lamp
white → **LD1005B3**





Circe table lamp
black → **LD1005N3**

Circe table lamp glossy
rose gold → **LD1005E3**

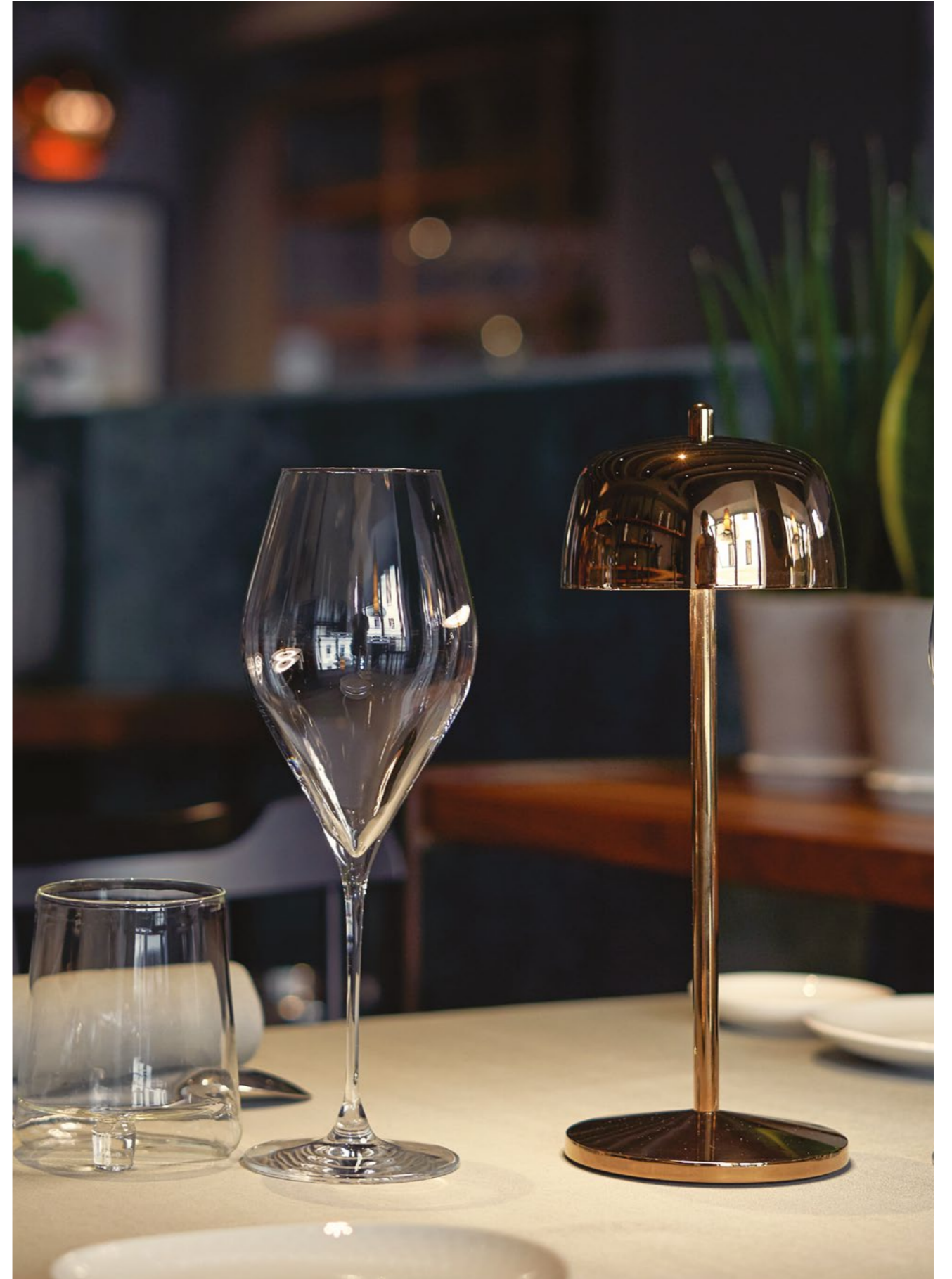

Dati tecnici

Technical data

LED DIMMER

2200-3000 K | CRI>80
214-224 lm | 2,2 W | IP65
5 Vdc max 1A



Corpo in pressofusione di alluminio verniciato
Painted die-cast aluminum body

Schermo diffusore in policarbonato prismatico
Prismatic polycarbonate diffuser

Adatta all'uso esterno (lampada IP65) e interno
(lampada su base di ricarica IP20)
Suitable for outdoor (lamp IP65) and indoor use
(lamp on charging base IP20)

Durata di circa 9 h alla massima potenza
Battery lasts about 9 h at full power

Tempo di ricarica a 1A: 6 h
Charging time at 1A: 6 h

Pacco batteria al litio ricaricabile e sostituibile
Rechargeable and replaceable lithium battery pack

Avvertenze

Remarks

Le lampade con finitura galvanica lucida oro e oro rosa non sono adatte per uso esterno.
The lamps with gold and rose gold glossy galvanic finish are not suitable for outdoor use.

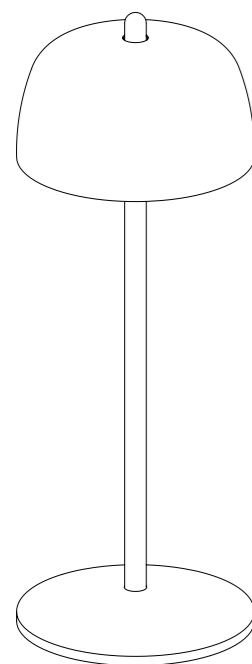

Ø 11 x 30 cm
Ø 4,3 x 11,8 in

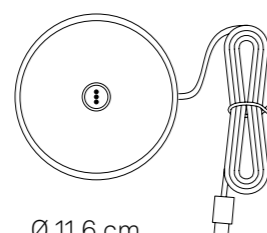

Ø 11,6 cm
Ø 4,5 in

Accessori inclusi

Accessories included

Base di ricarica a contatto
Contact charging base

Accessori non inclusi

Accessories not included

Caricatore / Charger
100-240 V | USB Type A
LD0490UA

Finiture

Finishes

**LD1005B3**

Bianco / White
RAL 9002

**LD1005R3**

Corten

**LD1005N3**

Nero / Black
RAL 9005

**LD1005O3**

Oro lucido / Glossy gold
Galvanic finish

**LD1005E3**

Oro rosa lucido / Glossy rose gold
Galvanic finish

Le lampade con finitura galvanica lucida oro e oro rosa non sono adatte per uso esterno.
The lamps with gold and rose gold glossy galvanic finish are not suitable for outdoor use.

Super O

Design Studio Kairos



Super O è una collezione di lampade a batteria, portatili e ricaricabili che comprende le tipologie da tavolo, terra (in tre modelli), terra sospesa (in tre modelli), parete (in due modelli) e a sospensione. Il modulo luminoso si fissa alla montatura di ciascun modello tramite un magnete, e - ruotando a 360° - permette di orientare la luce. Un controllo "touch" presente nella parte superiore del modulo permette l'accensione, la regolazione dell'intensità luminosa (dimmerazione a 4 step) e la selezione della temperatura di colore della luce tra 2700 K, 3150 K e 4000 K. Grazie a un alto indice di protezione, le lampade della collezione sono utilizzabili anche all'esterno. Possiedono un sistema di controllo elettronico che monitora l'autonomia residua e garantisce un flusso luminoso costante fino all'esaurimento della batteria, permettendo di ottimizzare le ricariche ed effettuarle sempre in maniera corretta. Il modulo si rimuove in modo pratico e si ricarica comodamente connettendolo all'apposito disco di ricarica a contatto. Caricabatterie non incluso.

Super O is a collection of portable, rechargeable battery-operated lamps that includes the following: table, floor (three models), ceiling-suspended floor (three models) and wall (two models) lamps, and a suspension lamp. The lighting module is attached to the frame of the lamps with a magnet. It can rotate 360°, allowing to direct the flow of light. On the head, a touch sensor allows you to switch it on, adjust the luminous intensity (4-step: 100%, 60%, 30%, 6%) and select the color temperature of the light to 2700 K, 3150 K or 4000 K. With the high IP rating, the lamps can also be used outdoors. They feature an electronic control system that monitors the remaining autonomy and ensures a constant luminous flux until the battery runs out; recharging is therefore optimized and always properly done. The module can be easily removed from the frame and conveniently recharged by connecting it to the contact charging base; battery charger not included.



Dati tecnici

Technical data

LED TOUCH DIMMER

2700-3150-4000 K | CRI>90
287-331-336 lm | 3,5 W | IP65
5 Vdc max 2A



Corpo in pressofusione di alluminio verniciato
Painted die-cast aluminum body

Schermo diffusore in policarbonato prismatico
Prismatic polycarbonate diffuser

Adatta all'uso esterno (lampada IP65) e interno
Suitable for outdoor (lamp IP65) and indoor use

Durata di 10 - 160 h, in base alla regolazione
del flusso luminoso
Battery lasts 10 - 160 h, depending on the
luminous flux setting

Tempo di ricarica a 2A: 5 h
Charging time at 2A: 5 h

Pacco batteria al litio ricaricabile e sostituibile
Rechargeable and replaceable lithium battery pack

Finiture

Finishes



LD1152B3
Bianco / White
RAL 9003



LD1152N3
Nero / Black
RAL 9005

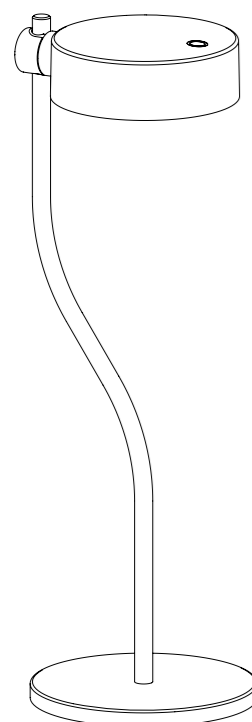

16,6 x 15 x 46 cm
6,5 x 5,9 x 18,1 in

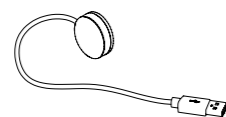

Ø 3 x 1 cm
Ø 1,2 x 0,4 in

Componenti inclusi

Components included

Disco per ricarica a contatto
Contact charging puck

Accessori non inclusi

Accessories not included

Caricatore / Charger
100-240 V | USB Type A (LD0300UC)



Super O table lamp
white → **LD1152B3**

Dati tecnici

Technical data

LED TOUCH DIMMER

2700-3150-4000 K | CRI>90
287-331-336 lm | 3,5 W | IP65
5 Vdc max 2A



Corpo in pressofusione di alluminio verniciato
Painted die-cast aluminum body

Schermo diffusore in policarbonato prismatico
Prismatic polycarbonate diffuser

Adatta all'uso esterno (lampada IP65) e interno
Suitable for outdoor (lamp IP65) and indoor use

Durata di 10 - 160 h, in base alla regolazione
del flusso luminoso
Battery lasts 10 - 160 h, depending on the
luminous flux setting

Tempo di ricarica a 2A: 5 h
Charging time at 2A: 5 h

Pacco batteria al litio ricaricabile e sostituibile
Rechargeable and replaceable lithium battery pack

Finiture

Finishes



Bianco / White
RAL 9003

1 Modulo luce
1 Lighting module
LD1154B3

2 Moduli luce
2 Lighting modules
LD1155B3

3 Moduli luce
3 Lighting modules
LD1156B3



Nero / Black
RAL 9005

1 Modulo luce
1 Lighting module
LD1154N3

2 Moduli luce
2 Lighting modules
LD1155N3

3 Moduli luce
3 Lighting modules
LD1156N3

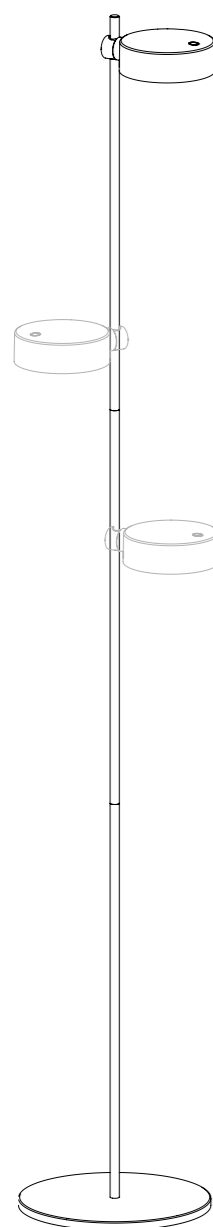

Ø 25 x 160 cm
Ø 9,8 x 63 in

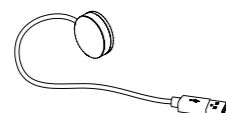

Ø 3 x 1 cm
Ø 1,2 x 0,4 in

Componenti inclusi

Components included

Disco per ricarica a contatto
Contact charging puck

Accessori non inclusi

Accessories not included

Caricatore / Charger
100-240 V | USB Type A (LD0300UC)

Super O floor lamp
(2 Lighting modules) black → **LD1155N3**



Dati tecnici

Technical data

LED TOUCH DIMMER

2700-3150-4000 K | CRI>90
287-331-336 lm | 3,5 W | IP65
5 Vdc max 2A

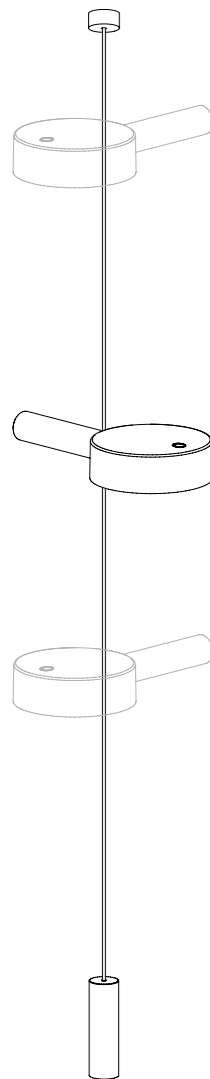

12,5 x 24,7 x 500 cm
4,9 x 9,7 x 196,9 in

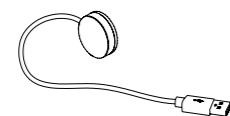

Ø 3 x 1 cm
Ø 1,2 x 0,4 in

Corpo in pressofusione di alluminio verniciato
Painted die-cast aluminum body

Schermo diffusore in policarbonato prismatico
Prismatic polycarbonate diffuser

Adatta all'uso esterno (lampada IP65) e interno
Suitable for outdoor (lamp IP65) and indoor use

Durata di 10 - 160 h, in base alla regolazione
del flusso luminoso
Battery lasts 10 - 160 h, depending on the
luminous flux setting

Tempo di ricarica a 2A: 5 h
Charging time at 2A: 5 h

Pacco batteria al litio ricaricabile e sostituibile
Rechargeable and replaceable lithium battery pack

Finiture

Finishes



Bianco / White
RAL 9003

1 Modulo luce
1 Lighting module
LD1157B3

2 Moduli luce
2 Lighting modules
LD1158B3

3 Moduli luce
3 Lighting modules
LD1159B3



Nero / Black
RAL 9005

1 Modulo luce
1 Lighting module
LD1157N3

2 Moduli luce
2 Lighting modules
LD1158N3

3 Moduli luce
3 Lighting modules
LD1159N3

Componenti inclusi

Components included

Disco per ricarica a contatto / Contact charging puck

Cavo di colore grigio scuro / Dark gray cable

Cavo di colore rosso / Red cable

Contrappeso da terra / Floor counterweight

Contrappeso modulo luce

Counterweight for lighting module

Accessori non inclusi

Accessories not included

Caricatore / Charger

100-240 V | USB Type A (LD0300UC)



Super O ceiling-suspended
floor lamp (1 Lighting module)
black → **LD1157N3**

Dati tecnici

Technical data

LED TOUCH DIMMER

2700-3150-4000 K | CRI>90
287-331-336 lm | 3,5 W | IP65
5 Vdc max 2A



Corpo in pressofusione di alluminio verniciato
Painted die-cast aluminum body

Schermo diffusore in policarbonato prismatico
Prismatic polycarbonate diffuser

Adatta all'uso esterno (lampada IP65) e interno
Suitable for outdoor (lamp IP65) and indoor use

Durata di 10 - 160 h, in base alla regolazione
del flusso luminoso
Battery lasts 10 - 160 h, depending on the
luminous flux setting

Tempo di ricarica a 2A: 5 h
Charging time at 2A: 5 h

Pacco batteria al litio ricaricabile e sostituibile
Rechargeable and replaceable lithium battery pack

Finiture

Finishes



LD1153B3
Bianco / White
RAL 9003



LD1153N3
Nero / Black
RAL 9005

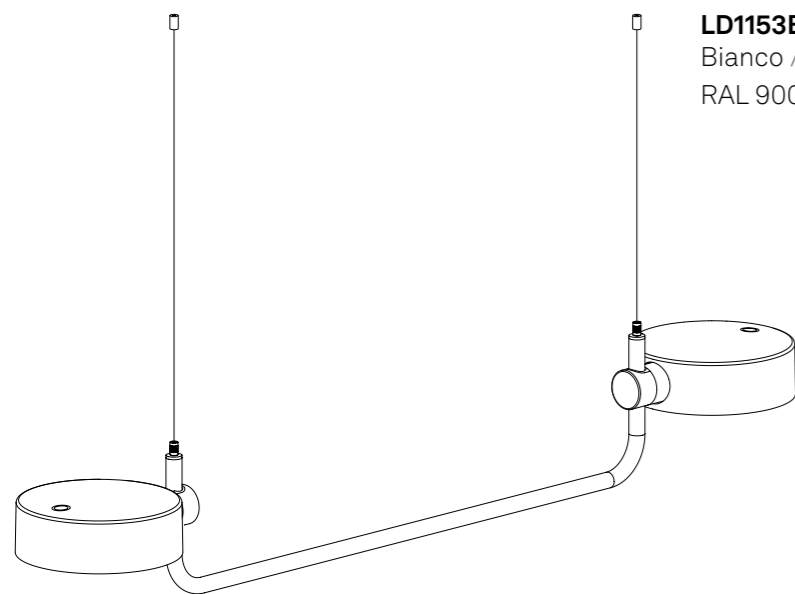

77 x 12,5 x 300 cm
30,3 x 4,9 x 118,1 in

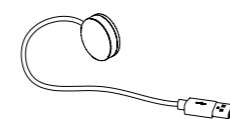

Ø 3 x 1 cm
Ø 1,2 x 0,4 in

Componenti inclusi

Components included

Disco per ricarica a contatto
Contact charging puck

Accessori non inclusi

Accessories not included

Caricatore / Charger
100-240 V | USB Type A (LD0300UC)



Super O suspension lamp
white → **LD1153B3**

Dati tecnici**Technical data****LED TOUCH DIMMER**

2700-3150-4000 K | CRI>90
287-331-336 lm | 3,5 W | IP65
5 Vdc max 2A



Corpo in pressofusione di alluminio verniciato
Painted die-cast aluminum body

Schermo diffusore in policarbonato prismatico
Prismatic polycarbonate diffuser

Adatta all'uso esterno (lampada IP65) e interno
Suitable for outdoor (lamp IP65) and indoor use

Durata di 10 - 160 h, in base alla regolazione
del flusso luminoso

Battery lasts 10 - 160 h, depending on the
luminous flux setting

Tempo di ricarica a 2A: 5 h

Charging time at 2A: 5 h

Pacco batteria al litio ricaricabile e sostituibile

Rechargeable and replaceable lithium battery pack

Finiture**Finishes**

LD1151B3
Bianco / White
RAL 9003



LD1151N3
Nero / Black
RAL 9005

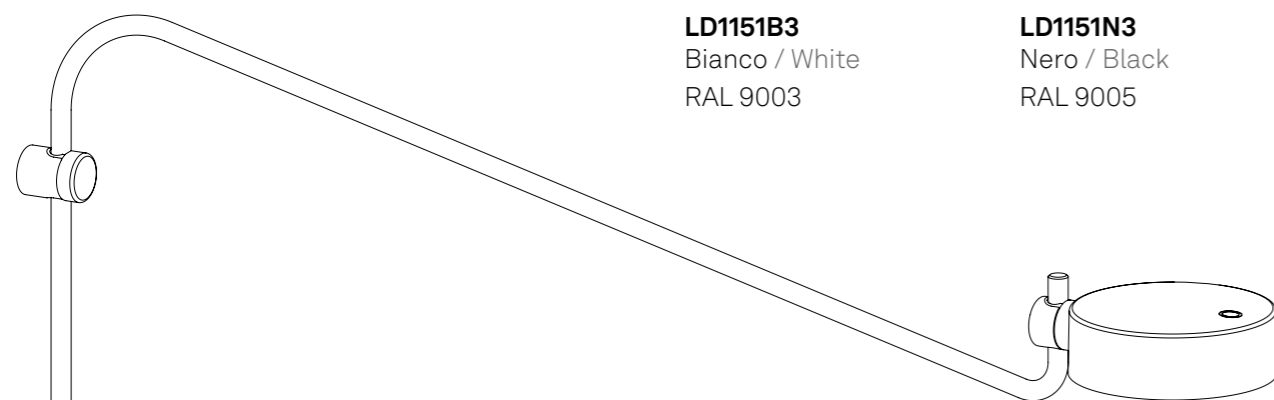

12,5 x 40,5 x 85,3 cm
4,9 x 15,9 x 33,6 in

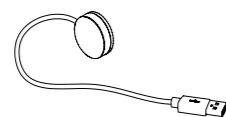

Ø 3 x 1 cm
Ø 1,2 x 0,4 in

Componenti inclusi

Components included

Disco per ricarica a contatto
Contact charging puck

Accessori non inclusi

Accessories not included

Caricatore / Charger
100-240 V | USB Type A (LD0300UC)

Super O wall lamp
white → **LD1151B3**



Dati tecnici

Technical data

LED TOUCH DIMMER

2700-3150-4000 K | CRI>90
287-331-336 lm | 3,5 W | IP65
5 Vdc max 2A



Corpo in pressofusione di alluminio verniciato
Painted die-cast aluminum body

Schermo diffusore in policarbonato prismatico
Prismatic polycarbonate diffuser

Adatta all'uso esterno (lampada IP65) e interno
Suitable for outdoor (lamp IP65) and indoor use

Durata di 10 - 160 h, in base alla regolazione
del flusso luminoso

Battery lasts 10 - 160 h, depending on the
luminous flux setting

Tempo di ricarica a 2A: 5 h

Charging time at 2A: 5 h

Pacco batteria al litio ricaricabile e sostituibile

Rechargeable and replaceable lithium battery pack

Finiture

Finishes

**LD1150B3**

Bianco / White
RAL 9003

**LD1150N3**

Nero / Black
RAL 9005

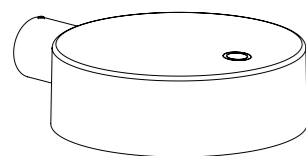

12,5 x 4,3 x 16,2 cm
4,9 x 1,7 x 6,4 in

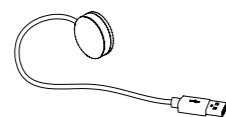

Ø 3 x 1 cm
Ø 1,2 x 0,4 in

Componenti inclusi

Components included

Disco per ricarica a contatto
Contact charging puck

Accessori non inclusi

Accessories not included

Caricatore / Charger
100-240 V | USB Type A (LD0300UC)



Super O wall lamp
black → **LD1150N3**

Liolà

Tavolo Table



Tavolini composti da un piano rotondo in termoplastico e tre gambe in legno di frassino, disponibili in otto varianti: alto oppure basso, con piano bianco oppure nero, con gambe in colore naturale oppure verniciate nere. Realizzati con materiali di qualità, in collaborazione con artigiani e laboratori selezionati, i tavolini Liolà sono progettati per un uso professionale nel settore ristorazione, ma sono adatti anche all'uso domestico, anche come svuotatasche o per appendere una borsa.

Tables composed of a round thermoplastic top and three ash wood legs, available in eight variations: tall or low, with a white or black top, with legs in natural color or painted black. Liolà tables are made in collaboration with selected artisans and workshops, using high quality materials, and are designed for professional use in restaurants, but are also suitable for home use, for example as a tray or to hang a bag.



Liolà high table
black - natural wood → **ZLS0104**



Liolà table
black - black wood → **ZLS0005**



Liolà high table
white - natural wood → **ZLS0101**



Liola table white - natural wood → **ZLS0001**
 Liola high table white - natural wood → **ZLS0101**

Dati tecnici Technical data

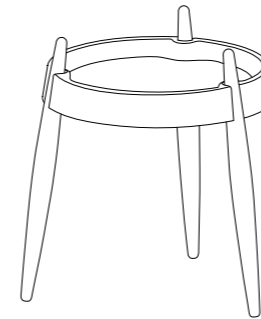

Ø 40 x 47 cm
 Ø 15,7 x 18,5 in

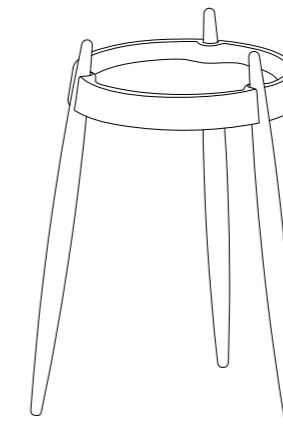

Ø 40 x 67 cm
 Ø 15,7 x 26,4 in

Piano in termoplastico
 Thermoplastic top
 Gambe in legno di frassino
 Wood legs



Finiture Finishes



ZLS0001
 Bianco - Frassino naturale
 White - Natural wood



ZLS0002
 Bianco - Frassino nero
 White - Black wood



ZLS0004
 Nero - Frassino naturale
 Black - Natural wood



ZLS0005
 Nero - Frassino nero
 Black - Black wood



ZLS0101
 Bianco - Frassino naturale
 White - Natural wood



ZLS0102
 Bianco - Frassino nero
 White - Black wood



ZLS0104
 Nero - Frassino naturale
 Black - Natural wood



ZLS0105
 Nero - Frassino nero
 Black - Black wood

Accessori

Accessories



LD0350RB
Base di ricarica a contatto
Contact charging base
(Poldina, Poldina mini)



LD0490RB
Base di ricarica a contatto
Contact charging base
(Poldina micro)



LD0395RB
Base di ricarica a contatto
Contact charging base
(Poldina L desk)

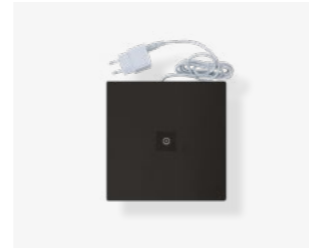

LD0390RB
Base di ricarica a contatto
Contact charging base
(Poldina L)



LD0800CS
Caricabatterie con connettore
3.5/1.3 (pag. 182)
(Pencil modulo luce,
Pencil base ricarica)
Charger with a 3.5/1.3
connector (page 182)
(Pencil lighting module,
Pencil charging base)

48W
INPUT: AC 100-240V | 50-60Hz
OUTPUT: 19Vdc - max 2,5 A



LD0490UA
Caricabatterie con entrata USB-a
USB-a port power charger
(Poldina micro, Swap mini,
Push-up)

INPUT: AC 100-240V | 50-60Hz
OUTPUT: 5Vdc - max 1 A



LD0300UC
Caricabatterie con doppia entrata
USB-a e spina intercambiabile
(EU/USA/UK)
Dual USB-a port power charger
and an interchangeable plug
suitable for EU/USA/UK
(Sister Light)

INPUT: AC 100-240V | 50-60Hz
OUTPUT: 5Vdc - max 2,1 A



CBL04200010000000
Cavo di ricarica con entrata USB-c
Charging cable with USB-c input
(Sister Light)



LD0360RB
Base di ricarica a contatto
Contact charging base
(Poldina XXL)



LD0850RB
Base di ricarica a contatto
Contact charging base
(Olivia, Olivia mini)



LD0870RB
Base di ricarica a contatto
Contact charging base
(Ofelia)

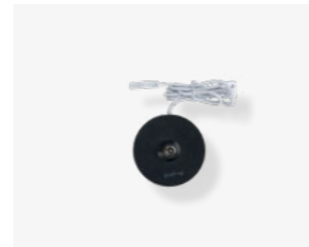

LD0688RB
Base di ricarica a contatto
(Poldina picchetto, Poldina
sospensione, Poldina parete)
Contact charging base
(Poldina lamp with peg,
Poldina suspension lamp,
Poldina wall lamp)

INPUT: AC 100-240V | 50-60Hz
OUTPUT: 5Vdc max 1A



LD0340RA
Caricatore multiplo 8 prese USB-a
8 x USB-a ports multi charger

40W
INPUT: AC 100-240V | 50-60Hz
OUTPUT: 5Vdc - max 8A (8 pcs.)



LD0350RP
Base di ricarica a contatto
multipla 6 posti
Multi-contact charging base
6 slots
(Poldina, Poldina mini, Poldina
Reverso, Pina, Swap, Swap
mini, Push-up, Home, Dama,
Olimpia)



LD0490RP
Base di ricarica a contatto
multipla 12 posti
Multi-contact charging base
12 slots
(Poldina micro)



LD0870RP
Base di ricarica a contatto
multipla 6 posti
Multi-contact charging base
6 slots
(Olivia, Olivia mini, Ofelia)



Base di ricarica a contatto
Contact charging base
LD0420RB (Poldina Reverso)
LD0650RB (Pina)
LD0610RB (Dama)
LD0900RB (Olimpia)
LD1010RB (Swap)
LD0258RB (Home)

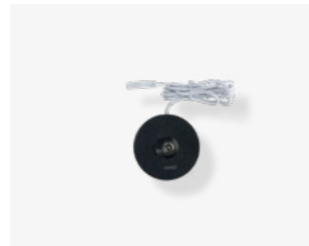

LD1011RB
Base di ricarica a contatto
Contact charging base
(Swap mini)

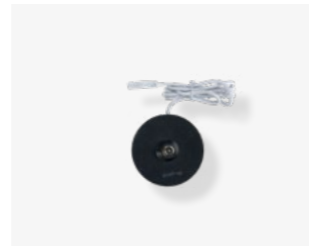

LD1050RB
Base di ricarica a contatto
Contact charging base
(Push-up)



LD0280UA
Caricabatterie con entrata USB-a e
cavo di ricarica con entrata USB-c
Charger with USB-a input and
charging cable with USB-c input

INPUT: AC 100-240V | 50-60Hz
OUTPUT: 5Vdc - max 1 A



LD0420V1
Contenitore multiuso
Multipurpose container tray
(Poldina Reverso)



LD0300KT
Kit per fissaggio meccanico
al tavolo
Kit for mechanical fixing
to a table
(Sister Light tavolo)

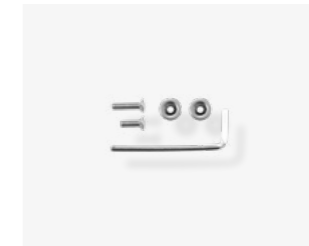

LD0300KN
Kit per fissaggio magnetico
(Sister Light)



LD0300KM
Kit per fissaggio meccanico
(Sister Light)

Accessori e ricambi

Accessories and spare parts



Super O
Modulo luce aggiuntivo
Additional lighting module
Bianco / White
LD1060B3



Super O
Modulo luce aggiuntivo
Additional lighting module
Nero / Black
LD1060N3

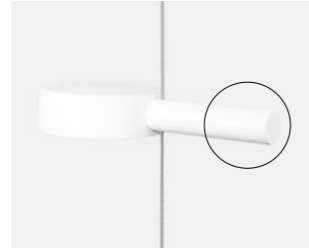

Super O
Contrappeso per modulo luce
Counterweight for additional
light module
Bianco / White
LD1063B3

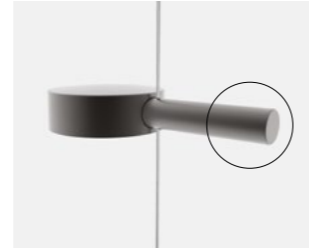

Super O
Contrappeso per modulo luce
Counterweight for additional
light module
Nero / Black
LD1063N3



Poldina
Stopper
LD0349A3 Blu Avio / Avio blue
LD0349B3 Bianco / White
LD0349D3 Nero / Black
LD0349F3 Rosso / Red
LD0349G3 Salvia / Sage green
LD0349S3 Sabbia / Sand

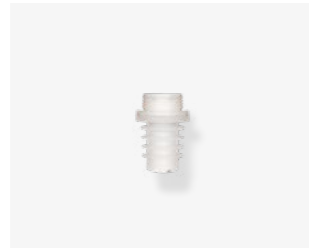

Poldina
Tappo per testa in silicone
Silicone head plug
LD0349TP



Caricabatterie con entrata USB
USB port power charger
LD0490UA

INPUT: AC 100-240V | 50-60Hz
OUTPUT: 5Vdc - max 1 A



Caricabatterie con doppia entrata USB
e spina intercambiabile (EU/USA/UK)
Dual USB port power charger and an
interchangeable plug suitable for EU/
USA/UK
LD0300UC

INPUT: AC 100-240V | 50-60Hz
OUTPUT: 5Vdc - max 2,1 A



Caricatore multiplo 8 prese USB
8 x USB ports multi charger

40W
INPUT: AC 100-240V | 50-60Hz
OUTPUT: 5Vdc - max 8A (8 pcs.)
LD0340RA



Poldina table lamp
Base di ricarica a contatto
multipla 6 posti
Multi-contact charging base
6 slots
LD0350RP

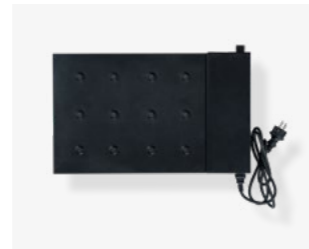

Poldina micro
Base di ricarica a contatto
multipla 12 posti
Multi-contact charging base
12 slots
LD0490RP



Amelie, Circe, Ofelia micro,
Olivia micro
Base di ricarica a contatto
multipla 6 posti
Multi-contact charging base
6 slots
LD0870RP

Accessori e ricambi

Accessories and spare parts



Amelie collection
Base di ricarica a contatto
Contact charging base
LD1090RB

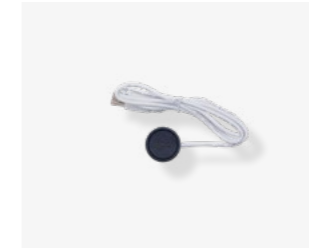

Super O collection
Disco per ricarica a contatto
Contact charging puck
LD1060RB



Circe table lamp
Base di ricarica a contatto
Contact charging base
LD1005RB



Ofelia micro
Base di ricarica a contatto
Contact charging base
LD1880RB

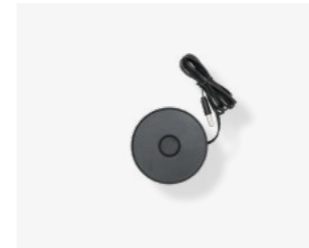

Olivia micro
Base di ricarica a contatto
Contact charging base
LD1840RB

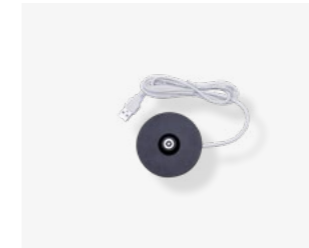

Sister Light collection
Base di ricarica a contatto
Contact charging base
LD1080RB



Sister Light table lamp
Adattatore per base di ricarica
Charging base adapter
LD1080BS



Pina
Base di ricarica a contatto
Contact charging base
LD0650RB



Poldina table lamp
Base di ricarica a contatto
Contact charging base
LD0350RB

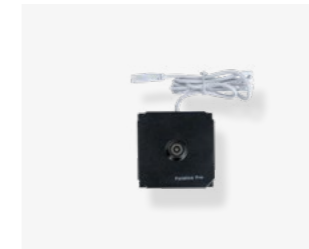

Poldina micro
Base di ricarica a contatto
Contact charging base
LD0490RB



Poldina suspension lamp,
Poldina wall lamp,
Poldina lamp with peg
Base di ricarica a contatto
Contact charging base
LD0688RB

Base di ricarica a contatto multipla (max 6 posti)

Multi-contact charging base (max 6 slots)

→ Poldina, Poldina mini, Poldina Reverso, Pina, Swap, Swap mini, Push-up, Home, Dama, Olimpia



→ LD0350RP

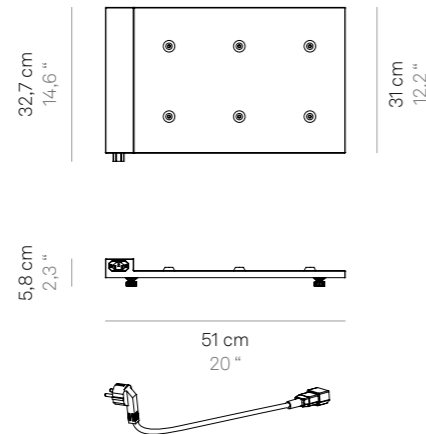

35W
INPUT: AC 100-240V | 50-60Hz
OUTPUT: 5Vdc max 6A

Base di ricarica a contatto multipla (max 6 posti) e modulare: più basi possono essere collegate in sequenza per caricare contemporaneamente più lampade. Particolarmente adatto all'uso professionale. Modular multi-contact (max 6 slots) charging base: they can be connected in sequence to simultaneously charge multiple set of lamps. Particularly suitable for professional use.

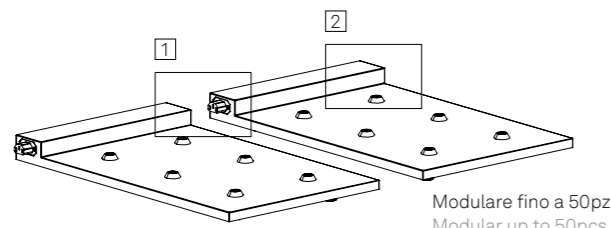
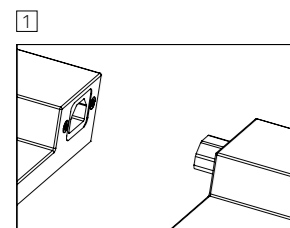

Modulare fino a 50pz
Modular up to 50pcs

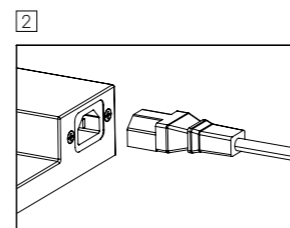
**Base di ricarica a contatto multipla (max 12 posti)**

Multi-contact charging base (max 12 slots)

→ Poldina micro



→ LD0490RP

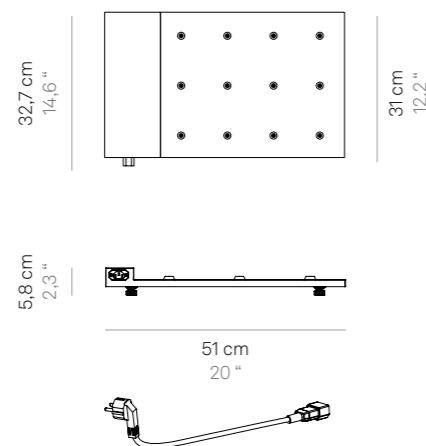

35W
INPUT: AC 100-240V | 50-60Hz
OUTPUT: 5Vdc max 12A

Base di ricarica a contatto multipla (max 12 posti) e modulare: più basi possono essere collegate in sequenza per caricare contemporaneamente più lampade. Particolarmente adatto all'uso professionale. Modular multi-contact (max 12 slots) charging base: they can be connected in sequence to simultaneously charge multiple set of lamps. Particularly suitable for professional use.

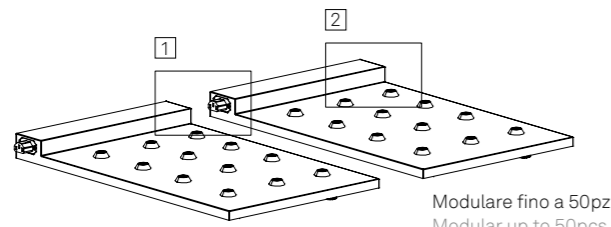
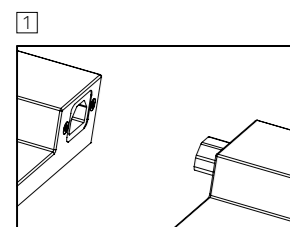

Modulare fino a 50pz
Modular up to 50pcs

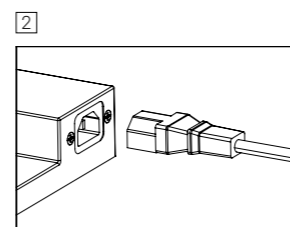
**Base di ricarica a contatto multipla (max 6 posti)**

Multi-contact charging base (max 6 slots)

→ Olivia, Olivia mini, Ofelia



→ LD0870RP

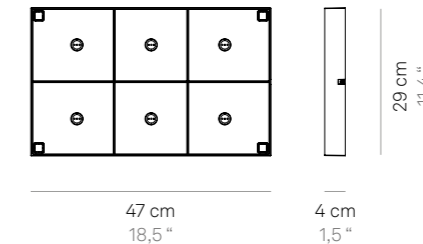

45W
INPUT: AC 100-240V | 50-60Hz
OUTPUT: 9Vdc max 5A

Base di ricarica a contatto multipla (max 6 posti) e modulare: più basi possono essere impilate (fino a max 3 livelli) per caricare contemporaneamente più lampade. Particolarmente adatto all'uso professionale. Modular multi-contact (max 6 slots) charging base: they can be stacked (up to max 3 levels) to simultaneously charge multiple set of lamps. Particularly suitable for professional use.

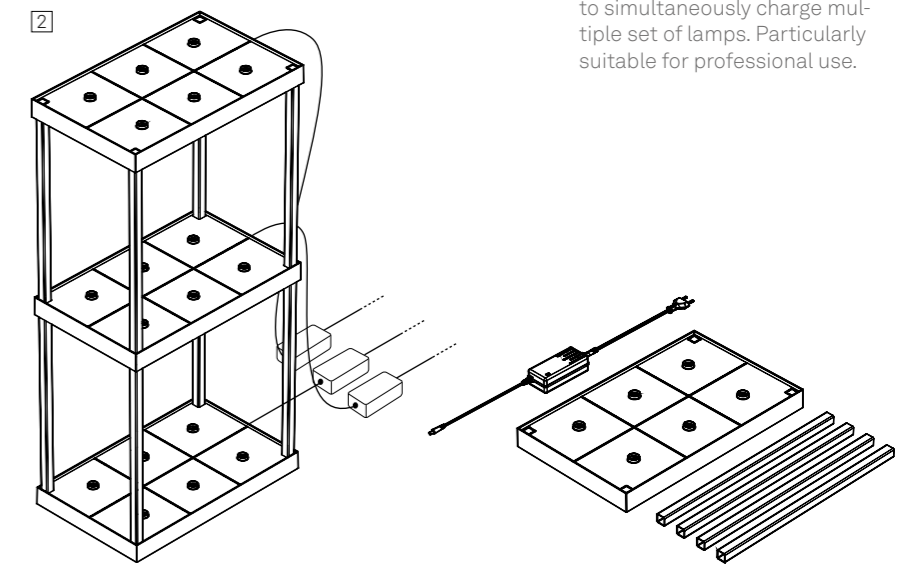
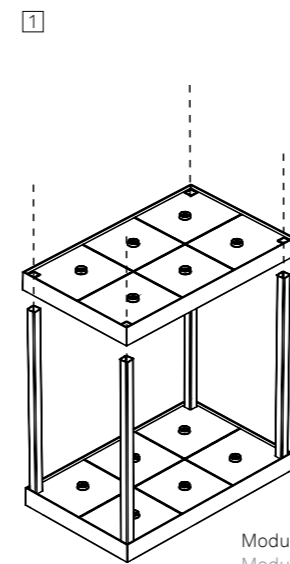

Modulare fino a 3 livelli.
Modular up to 3 levels.

Caricatore multiplo 8 prese USB

8 x USB ports multi charger



→ LD0340RA

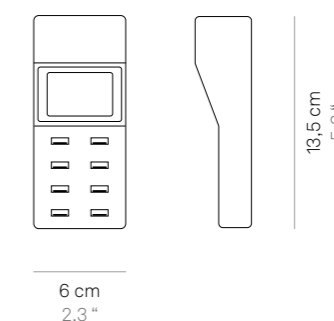

40W
INPUT: AC 100-240V | 50-60Hz
OUTPUT: 5Vdc - max 8A (8 pcs.)

Caricatore multipresa USB (8 x USB-A). Permette la carica di max 8 dispositivi contemporaneamente. Un display mostra graficamente il livello delle batterie in ricarica. Particolarmente adatto all'uso professionale. USB multi-socket charger (8 x USB-A). Can charge of up to 8 devices simultaneously. A graphic display shows the level of the batteries being charged. Particularly suitable for professional use.

Batterie ricaricabili

Rechargeable batteries

Le batterie ricaricabili sono soggette ad usura. La vita delle batterie, il cui standard è di circa 450 ricariche, può essere ridotta da alcuni fattori come: ① la modalità non corretta di ricarica (la lampada va ricaricata quando è scarica: circa il 10% della sua autonomia residua); ② lunghi periodi di stazionamento senza utilizzo; ③ lunghi periodi di stazionamento su base di ricarica in tensione anche se la lampada risulta carica; ④ l'utilizzo di accessori non originali per la ricarica; ⑤ l'esposizione del prodotto a temperature molto alte o molto fredde. Quando le lampade non si ricaricano più o l'autonomia risulta molto ridotta, le batterie devono essere sostituite. I ricambi delle lampade ricaricabili Zafferano sono disponibili a catalogo e identificati con apposito codice. La garanzia sulle batterie è valida solo per difetti di fabbricazione, che si manifestano al primo utilizzo.

All rechargeable batteries are subject to wear when used. The life of batteries, which can generally be recharged 450 times, may be reduced by certain factors: ① incorrect recharging mode (the lamp must be recharged when it is flat: about 10% of its remaining autonomy); ② when left unused for a long time; ③ when left for a long time on a live recharging base even if the lamp is recharged; ④ when non-original accessories are used for recharging; ⑤ when the product is exposed to very high or very low temperatures. When the lamps no longer recharge or their autonomy after recharging is very short, the batteries must be replaced. Spare parts for Zafferano rechargeable lamps can be found in the catalogue and identified by a special code. The warranty for batteries is only valid for manufacturing defects, if occurred at first use.

BAT04701906701900 3,7V | 1x2200mA/H
Pacco batteria sostitutiva singola (necessari 2 pz., per **Pina tavolo, Push-up tavolo, Home tavolo**; necessari 3 pz., per **Poldina L desk tavolo, Poldina L terra-tavolo**)
Single replacement battery pack (x2 pcs., needed for **Pina table lamp, Push-up table lamp, Home table lamp**; x 3 pcs., needed for **Poldina L desk table lamp, Poldina L floor-table lamp**)



BAT04704004001000 3,7V | 1x1900mA/H
Pacco batteria sostitutiva singola (necessario 1 pz., per **Poldina micro tavolo**)
Single replacement battery pack (1 pc., needed for **Poldina micro table lamp**)



BAT04703706701900 3,7V | 2x2200mA/H
Pacco batteria sostitutiva doppia (necessario 1 pz., per **Poldina tavolo, Poldina mini tavolo, Poldina picchetto, Poldina sospensione, Poldina parete, Poldina Reverso tavolo, Olivia, Olivia mini, Ofelia, Dama, Olimpia**; necessari 3 pz., per **Poldina XXL terra-tavolo**)
Double replacement battery pack (1 pc., needed for **Poldina table lamp, Poldina mini table lamp, Poldina lamp with peg, Poldina suspension lamp, Poldina wall lamp, Poldina Reverso table lamp, Olivia, Olivia mini table lamp, Ofelia, Dama, Olimpia**; 3 pcs., needed for **Poldina XXL floor-table lamp**)



BAT04701906701902 3,7V | 1x2600mA/H
Pacco batteria sostitutiva singola (necessari 2 pz., per **Swap tavolo, Swap tavolo mini**)
Single replacement battery pack (2 pcs., needed for **Swap table lamp, Swap mini table lamp**)



BAT04705506701900 3,7V | 7500mA/H
Pacco batteria sostitutiva tripla (necessario 1 pz., per **Sister Light tavolo, Sister Light mini tavolo, Sister Light picchetto, Sister Light parete**)
Triple replacement battery pack (x 1 pc., needed for **Sister Light table lamp, Sister Light mini table lamp, Sister Light lamp with peg, Sister Light wall lamp**)



BAT04702719700300 11,1V | 5000mA/H
Pacco batteria sostitutiva per **modulo Pencil piccolo**
Replacement battery pack for **small Pencil module**



BAT04702739200600 11,1V | 10000mA/H
Pacco batteria sostitutiva per **modulo Pencil medio**
Replacement battery pack for **medium Pencil module**



BAT04702758700900 11,1V | 15000mA/H
Pacco batteria sostitutiva per **modulo Pencil grande**
Replacement battery pack for **large Pencil module**



Video tutorial:
sostituzione batterie
Tutorial video:
battery replacement

Personalizzazione

Customization

Su richiesta, con quantitativi minimi d'ordine, è possibile personalizzare le lampade con un servizio di logatura.

Available on request, with minimum ordering quantities, customised logo pad-printing service.



Punti personalizzabili
Customizable spots

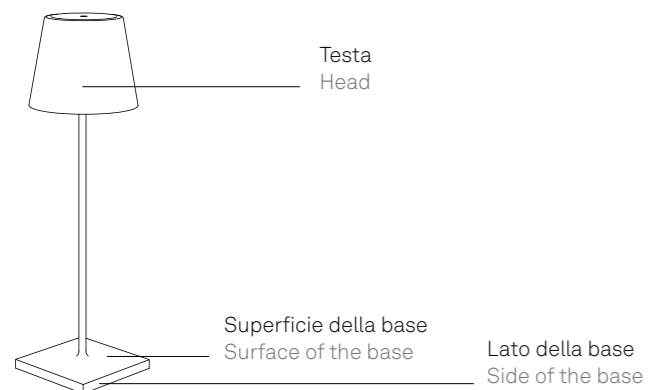

Bauli: logatura sul lato della base
Bauli: customization on the side of the base
(Poldina table lamp pro, LD0340P3)



Barilla: logatura sulla superficie della testa
Barilla: customization on the surface of the head
(Sister Light table lamp pro, LD030003 + LD0300R3)





Bulldog: logatura sulla testa
Bulldog: customization on the head
(Poldina micro table lamp pro, LD0490D3)



Logatura su cover in metallo, per modelli Poldina
Customization on metallic cover, available for Poldina



Zafferano: logatura sulla superficie della base
Zafferano: customization on the surface of the base
(Poldina table lamp pro, LD0340B3)

<p>CE</p> <p>CE Dichiara che il prodotto soddisfa gli standard dell'UE per la salute, la sicurezza e la protezione ambientale. Declares that the product meets EU standards for health, safety, and environmental protection.</p>	<p></p> <p>CLASS II Apparecchio dotato di doppio isolamento e/o isolamento rinforzato in ogni parte e senza dispositivo di messa a terra. Light fitting equipped with double isolation and/or isolation reinforced in every part and without earthing device.</p>	<p></p> <p>CLASS III Apparecchio basato su un'alimentazione a bassissima tensione di sicurezza, in cui non si producono tensioni superiori alla stessa. Light fitting based on a very low safety voltage power supply, in which no tensions higher than the same are produced.</p>	<p>IP</p> <p>IP PROTECTION DEGREE IP20: apparecchio protetto dalla penetrazione di corpi solidi di dimensioni maggiori a 12mm e non protetto dai liquidi. IP54: apparecchio protetto da polveri e da spruzzi d'acqua. IP65: apparecchio fortemente protetto da polveri e da getti d'acqua. IP20: protected from the penetration of solid objects greater than 12 mm and non protected from liquids. IP54: protected from dust and splashing water. IP65: highly protected from dust and water jets.</p>
<p></p> <p>DIMMABLE Indica che è possibile regolare l'intensità luminosa della lampada. Indicates that the light intensity of the lamp can be adjusted.</p>			

Headquarters
Zafferano SRL
Viale dell'industria 26
31055 Quinto di Treviso (TV), Italy
T +39 0422 470507
F +39 0422 470400
vendite@zafferanoitalia.com

Subsidiary
Zafferano America LLC
301 Penhorn Avenue
Suite 5,
Secaucus, NJ 07094
T +1 888 744 5277
info@zafferanoamerica.com

Showrooms
Zafferano Store Milano
Via Fatebenefratelli, 23
Milan (Italy)
Zafferano Store Treviso
Viale dell'Industria, 26
Quinto di Treviso (Italy)

Art Direction, Graphic Design
Zafferano Design

Photography
Claudio Mainardi
Alberto Sinigaglia
Quasar

Poems
Federico de Majo

©2023 Peanuts Worldwide LLC
www.peanuts.com

Acknowledgements
Porto Caleri, Rovigo
Caglieron Caves, Treviso
Storga river springs, Treviso
Morgano countryside, Treviso
Piave riverbed, Treviso
Brent de l'Art, Belluno
Rosolina pine forest, Rovigo
Cansiglio forest, Treviso
Euganean hills, Padua
(Italy)

Lago Design, Villa del Conte
Padua, Italy

L'azienda si riserva di apportare modifiche e/o migliorie di carattere tecnico ed estetico ai propri modelli e prodotti in qualsiasi momento e senza preavviso.
The company reserves the right to make modifications and improvements of a technical or aesthetic nature to the products at any time without notice.

Il prodotto è protetto da garanzia, a norma di legge.
The product is covered by a warranty, according to the law.

© Copyright Zafferano SRL

CATLAP23-10 + NEWLAP24-01

zafferanoitalia.com
zafferanolampesaporter.com
zafferanoamerica.com
poldina.com

zafferano
LAMPES-À-PORTER